

Daily ISO Phantom Package

Model 023 Series



AFFORDABLE "TURNKEY" SOLUTION FOR DAILY MACHINE QA



CIRS

900 Asbury Ave • Norfolk, Virginia 23513 • USA • Tel: 757-855-2765 • WWW.CIRSINC.COM

CAPABILITIES

- Check laser alignment; light field size; radiation vs. light field alignment; kV, MV and CBCT isocenter coincidence.
- Analyze RT and CR images
- Utilize same image sequences for different ISO center analysis
- Automatically sorts RT images
- Analyze multiple LINACs with single package
- Export results as PDF for convenient electronic filing

CIRS

Overview

Accurate radiation dose delivery requires daily checks of the alignment between the true radiation isocenter and the isocenters of the imaging, localization and targeting systems. The CIRS Daily ISO Phantom provides a cost-effective, quick, and accurate means for testing isocenter coincidence.

Using the Daily ISO Phantom, LINAC lasers and light field can be “tuned” to the true radiation isocenter using the engraved markings on the phantom’s exterior. The light field and radiation field alignment can be checked using built-in radiographic markers. More importantly, the isocenters of both the OBI and the EPID can be checked for true spatial alignment and coincidence with that of the treatment beam.

The Daily ISO Phantom contains a center and offset target. Both targets measure 6.35 mm in diameter and are made of ceramic. Together, the center target and engraved external concentric circles provide greater accuracy when localizing the center of the phantom to the center of the radiation field. The offset target is used to ensure the table offset coordinates generated by kV/MV matching are accurate.

The ISO Base™ is used to position and level the Daily ISO Phantom on the treatment couch. It contains integrated pixel calibration targets recognized by ISO Analyze™.

6DOF ISO Base™ is designed for positioning and leveling of the Daily ISO Phantom and quick calculation of complex 3D shifts of RT treatment systems with an integrated 6DOF robotic couch. 6DOF ISO Base integrates with ISO Analyze™ and maintains all functionality of ISO Base™.

ISO Analyze™ integrates with the Daily ISO Phantom, ISO Base™ and 6DOF ISO Base™ enabling user-friendly quality control of the LINAC isocenters by analyzing DICOM images acquired with the EPID, kV and CBCT. Controls are run automatically, analyzing images of the phantom and quantifying a large number of evaluation parameters. The software allows users to easily generate, save and print a report for each preceding control.

The phantom, base and software were designed for daily system checks. Results from ISO Analyze can be used to determine what adjustments are needed to align LINAC laser and light fields to the true radiation isocenter. The light field and radiation field alignment can be checked using the phantom’s built-in radiographic markers. More importantly, the isocenters of both the CBCT and the EPID can be checked for true spatial alignment and coincidence with that of the treatment beam.

Computerized Imaging Reference Systems, Inc is recognized world wide for tissue simulation technology and is the leader in the manufacture of phantoms and simulators for medical imaging and radiotherapy.

www.cirsinc.com

System Analysis in 5 Easy Steps

✓ DEFINE

One time setup for each LINAC requires:

- LINAC Identity
- Acquisition Conditions
- Acquisition Sequences

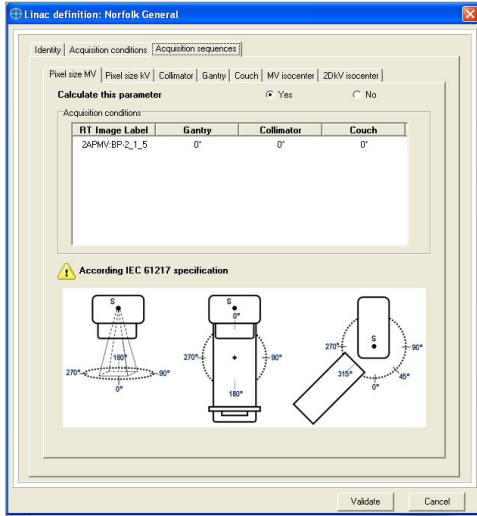

✓ ACQUIRE

8:30 - 8:45

ISO Analyze™ Software provides suggested image sequences for each parameter

Acquire images for analysis of all parameters.

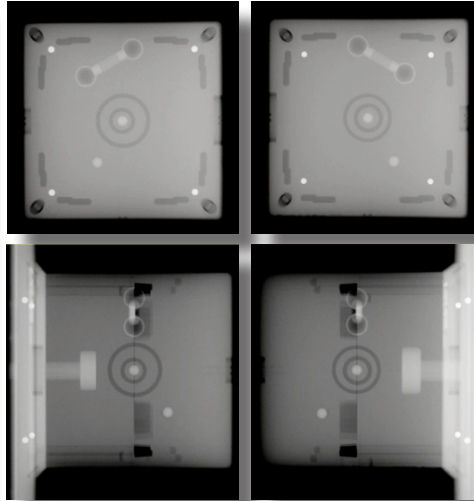

✓ SELECT

8:45 - 8:47

Select acquired DICOM images to use in each parameter calculation

Select images are automatically validated for each parameter

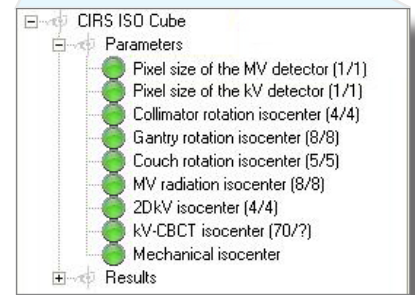
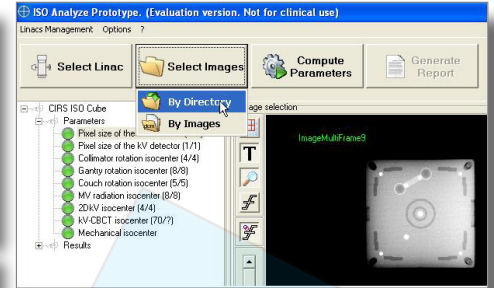

✓ CALCULATE AND ANALYZE RESULTS

8:47 - 8:55

ISO Analyze™ quickly calculates parameters and displays detailed results

Detailed results can be manipulated for in-depth analysis

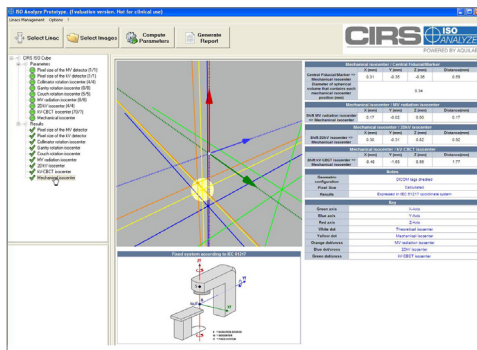

✓ REPORT

8:55 - 8:57

Summary report is displayed and PDF document may be printed and saved

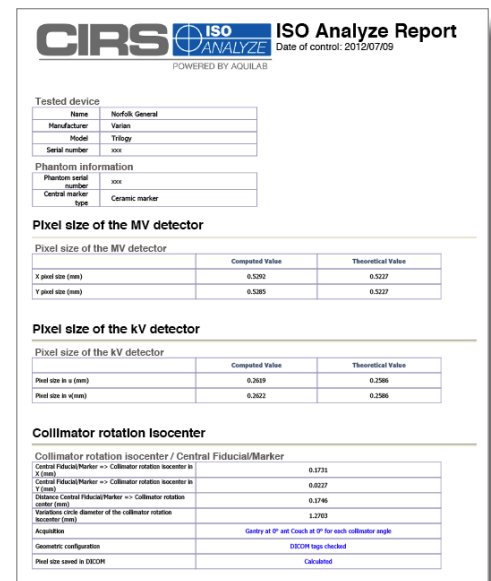

Daily ISO Phantom

The Daily ISO™ Phantom was designed for daily system checks. The Daily ISO Phantom is aligned to the true radiation isocenter through use of LINAC lasers, light field and engraved markings on the exterior of the phantom. The light field and radiation field alignment can be checked using integrated radiographic markers. More importantly, the isocenters of both the EPID and the CBCT can be checked for true spatial alignment and coincidence with that of the treatment beam.

The phantom contains a unique center point fiducial and an offset target. The offset target is used to ensure the table offset coordinates generated by kV/MV imaging are accurate by locating the target, moving the table the determined amounts and verifying that the offset target has been positioned at the isocenter. The center fiducial and off-set target measure 6.35 mm in diameter and are made of ceramic. The exterior is machined with concentric circle targets to allow users to objectively assess all setup errors, including rotations, and to easily align the phantom to the true radiation isocenter. ISO phantom is manufactured with machining tolerance of ± 0.02 mm. Target positioning accuracy is ± 0.1 mm.

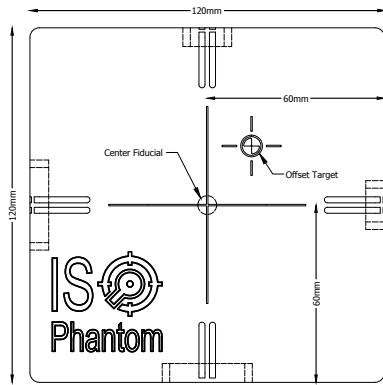

Inferior / Superior View

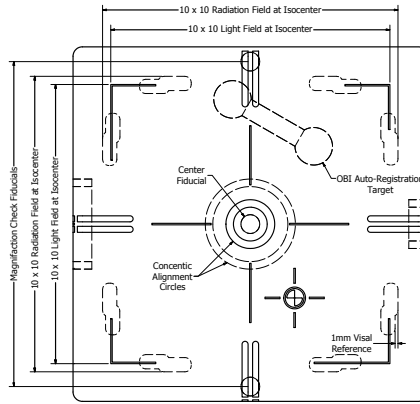

Anterior / Posterior View

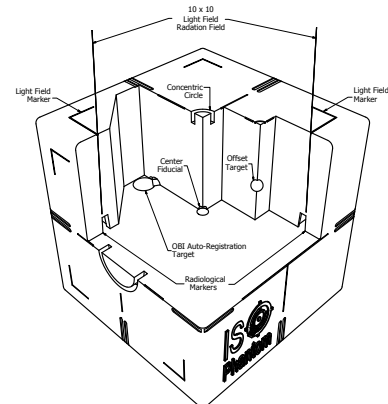

Interior View

6DOF ISO Base

The 6DOF ISO Base™ is designed for positioning and leveling of the Daily ISO Phantom and to allow quick calculation of complex 3D shifts of RT treatment systems with an integrated 6DOF robotic couch. There are two milled pockets on the 6DOF ISO Base. The ISO alignment pocket can be used to position and level the Daily ISO Phantom on the treatment couch. When positioned in the shifted 6DOF pocket, internal structures of the Daily ISO Phantom allows for the calculation of rotation and translation shifts. The shifted 6DOF pocket is machined with mechanical limits of commercially available couches in mind, which can correct for Pitch, Roll and Yaw of ± 3 degrees of rotation.

The 6DOF pocket is rotated within the IEC 61217 Coordinate System, $+1.5^\circ$ about X-axis, $+2.0^\circ$ about Y-axis and $+2.5^\circ$ about Z-axis and translated -15 mm on X-axis, +25 mm on Y-axis and -2 mm on Z-axis. The translations about the X, Y and Z-axes are applied with respect to the ISO center of the phantom. Having rotational shifts smaller than the mechanical limits of the robotic couches allows the user to determine if there are errors on either side of the induced shift.

Both the ISO alignment pocket and the 6DOF pocket are CNC machined in a single setup. The 6DOF ISO Base is also assembled as a single piece to minimize cumulative assembly errors.



ISO Base™ Alignment Platform

The ISO Base™ is used to position and level the Daily ISO Phantom on the treatment couch. It contains a set of four tungsten spheres that are used by ISO Analyze™ Software to calculate the actual pixel size for both the MV and kV image detectors. The tungsten spheres are positioned so as not to interfere with the alignment of the Daily ISO phantom. The spheres also do not interfere with the X-ray projections of the phantom internal and external features, which are used for alignment and isocenter calculations. The platform is also equipped with leveling legs.

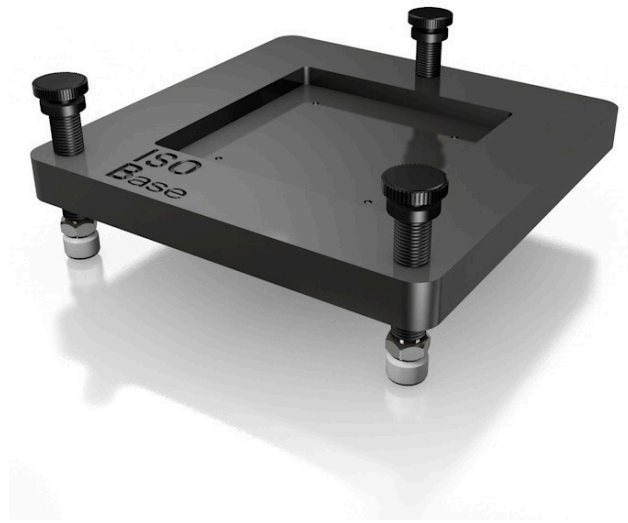

ISO Analyze™ Software

ISO Analyze™ integrates with the Daily ISO Phantom, 6DOF ISO Base and ISO Base™, enabling user-friendly quality control of the LINAC isocenters by analyzing DICOM images acquired with the EPID, kV and CBCT. Controls are run automatically, analyzing images of the phantom and quantifying a large number of evaluation parameters. The software allows users to easily generate, save and print a report for each preceding control.

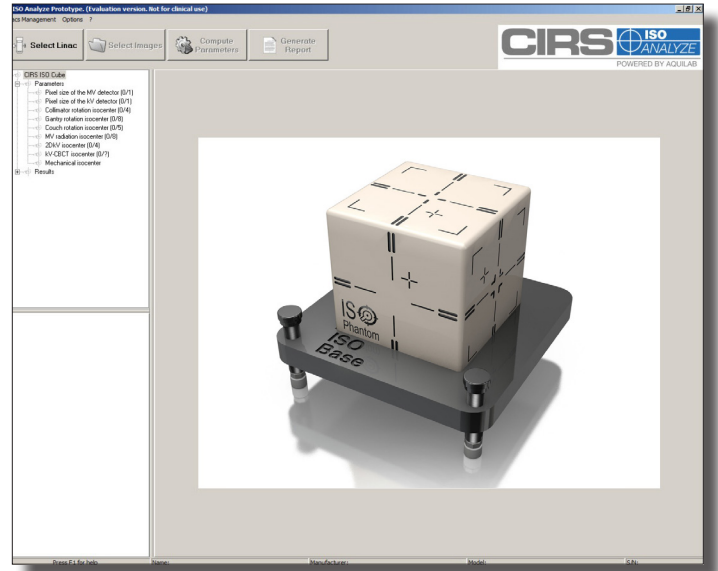

ISO ANALYZE SISTER LICENSE

CIRS ISO Analyze Image Analysis Software can only be installed on a single computer. From this workstation, customers can perform QA for any LINAC in the same network by accessing images acquired from these machines through the network connection. For larger hospital systems looking to install ISO Analyze Software on multiple computers, a sister license is available for purchase. The ISO Analyze Sister License (Model 023-07) has all of the same functionality as the full ISO Analyze main license, but will only be available to customers who have already purchased at least one Daily ISO Phantom and main ISO Analyze license.

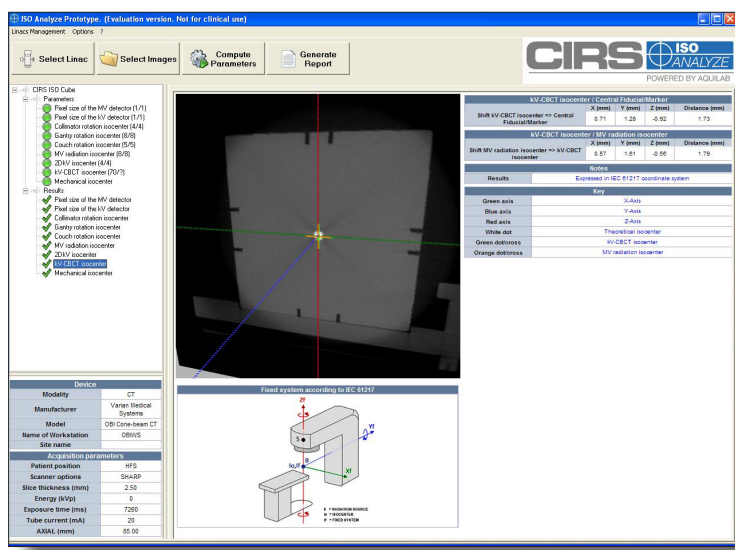
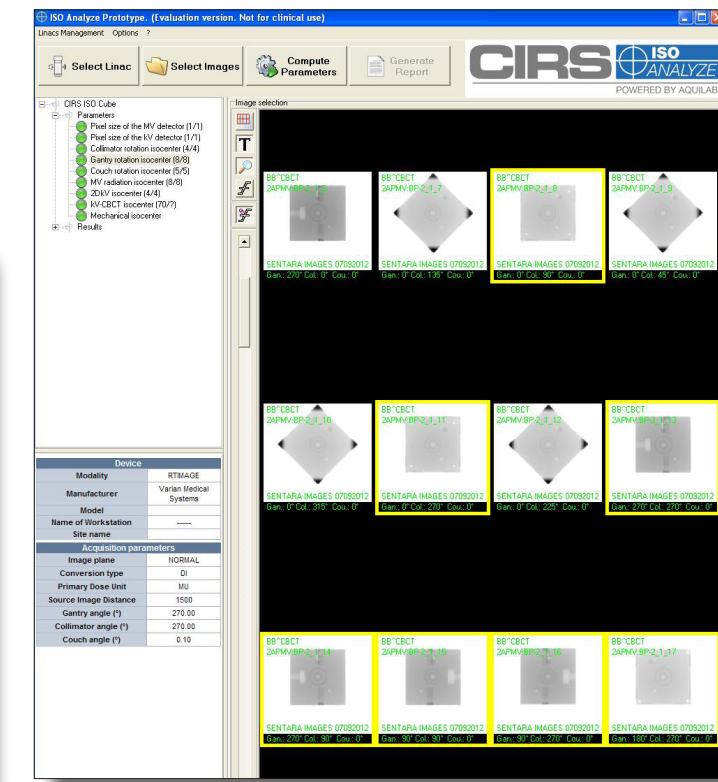

Ordering Information

PHANTOM BODY	Dimensions: 12 cm x 12 cm x 12 cm Weight: 1.7 kg Material: Plastic Water®
PHANTOM FIDUCIALS	Qty: Four (1) Center Fiducial (1) Offset Target (2) Magnification Check Fiducials Material: Ceramic Diameter: 6.35 mm
PHANTOM OBI AUTO REGISTRATION TARGET	Qty: One Material: Aluminum

CIRS ISO ANALYZE SOFTWARE SYSTEM REQUIREMENTS

Windows XP® / Vista / Windows 7 / 8 / 8.1 / 10
(32 or 64 bit)
Intel i3 or above (or equivalent AMD)
4 MB RAM
2 GB of available disk space (recommended)

OPTIONAL ACCESSORIES

PART NO.	DESCRIPTION
023-07	ISO Analyze Sister License

MODEL 023 INCLUDES

QTY	DESCRIPTION
1	Daily ISO Phantom
1	User Guide
-	60 Month Warranty

MODEL 023-05 INCLUDES

QTY	PART NO.	DESCRIPTION
1	023	Daily ISO Phantom
1	023-03	ISO Analyze™ Image Analysis Software
1	023-04	ISO Base™ Alignment Platform
1	-	User Guide
-	-	60 Month Warranty

MODEL 023-09 INCLUDES

QTY	PART NO.	DESCRIPTION
1	023	Daily ISO Phantom
1	023-03	ISO Analyze™ Image Analysis Software
1	023-08	6DOF ISO Base™
1	-	User Guide
-	-	60 Month Warranty

Warranty

All standard CIRS products and accessories are warranted by CIRS against defects in material and workmanship for a period as specified below. During the warranty period, the manufacturer will repair or, at its option, replace, at no charge, a product containing such defect provided it is returned, transportation prepaid, to the manufacturer. Products repaired in warranty will be returned transportation prepaid.

There are no warranties, expressed or implied, including without limitation any implied warranty of merchantability or fitness, which extend beyond the description on the face hereof. This expressed warranty excludes coverage of, and does not provide relief for, incidental or consequential damages of any kind or nature, including but not limited to loss of use, loss of sales or inconvenience. The exclusive remedy of the purchaser is limited to repair, recalibration, or replacement of the product at manufacturer's option.

This warranty does not apply if the product, as determined by the manufacturer, is defective because of normal wear, accident, misuse, or modification.

NON-WARRANTY SERVICE

If repairs or replacement not covered by this warranty are required, a repair estimate will be submitted for approval before proceeding with said repair or replacement.

RETURNS

If you are not satisfied with your purchase for any reason, please contact Customer Service prior to returning the product. Call 800-617-1177, email rma@circinc.com, or fax an RMA request form to 757-857-0523. CIRS staff will attempt to remedy the issue via phone or email as soon as possible. If unable to correct the problem, a return material authorization (RMA) number will be issued. Non-standard or "customized" products may not be returned for refund or exchange unless such product is deemed by CIRS not to comply with documented order specifications. You must return the product to CIRS within 30 calendar days of the issuance of the RMA. All returns should be packed in the original cases and or packaging and must include any accessories, manuals and documentation that shipped with the product. The RMA number must be clearly indicated on the outside of each returned package. CIRS recommends that you use a carrier that offers shipment tracking for all returns and insure the full value of your package so that you are completely protected if the shipment is lost or damaged in transit. If you choose not to use a carrier that offers tracking or insure the product, you will be responsible for any loss or damage to the product during shipping. CIRS will not be responsible for lost or damaged return shipments. Return freight and insurance is to be pre-paid.

WITH RMA NUMBER, ITEMS MAY BE RETURNED TO:

CIRS
Receiving
900 Asbury Ave,
Norfolk, Virginia, 23513 USA

PRODUCT	WARRANTY PERIOD
Daily ISO Phantom	60 months

6DOF ISO BASE FEATURES

- Fully compatible with all ISO Phantom and ISO Analyze Software
- 6DOF ISO Base Pockets allow easy position of ISO Phantom for ISO Center and Couch shift checks
- Compute kV and MV pixel size with embedded BBs
- Integrated leveling feet allow fine alignment adjustments
- Milled slots enable indexing with most localization bars

CIRS



**COMPUTERIZED IMAGING
REFERENCE SYSTEMS, INC.**

900 Asbury Ave
Norfolk, Virginia 23513 USA

Toll Free: 800.617.1177

Tel: 757.855.2765

Fax: 757.857.0523

E-mail admin@circinc.com

www.circinc.com

Technical Assistance

1.800.617.1177



Computerized Imaging Reference Systems, Inc. has
been certified by UL DQS Inc. to **(ISO) 13485:2016**.
Certificate Registration No.10000905-MP2016.

©2016- Computerized Imaging Reference Systems Inc.
All rights reserved. All brand names, product names or trademarks
belong to their respective holders.
Specifications subject to change without notice.
Publication: 023 PB 111020