

Dynamic Thorax Phantom

Model 008A

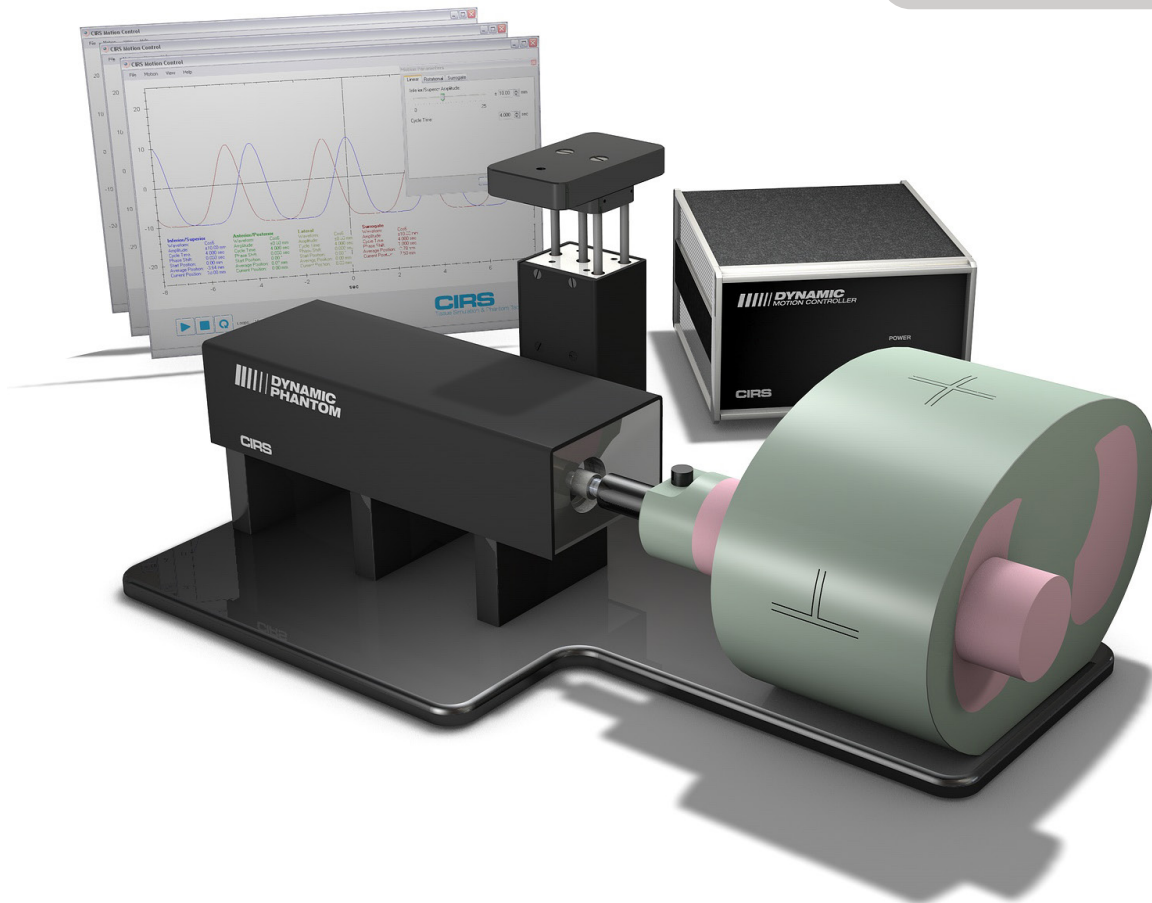

IMAGE ACQUISITION • TREATMENT PLANNING QA • DOSE DELIVERY

"Strict QA procedures for the imaging, planning and delivery of radiotherapy using respiratory management devices are required to ensure the safe and effective use of these devices."

AAPM TG-76 report
The management of respiratory
motion in radiation oncology



Patent # US 7,151,253 B2

900 Asbury Ave • Norfolk, Virginia 23513 • USA
Tel: 800.617.1177 • 757.855.2765 • Fax: 757.857.0523

WWW.CIRSSINC.COM

CIRS

Tissue Simulation & Phantom Technology

CAPABILITIES

- Commission 4D imaging and 4D radiotherapy systems
- Quantify volumetric and positional aliasing of CT in the presence of 3D target motion
- Evaluate static and dynamic target localization accuracy of onboard imaging systems
- Test accuracy and consistency of tumor tracking and respiratory gating devices
- Assess dosimetric accuracy of temporally modulated radiation therapy
- Train and evaluate personnel during implementation of new equipment and techniques

FEATURES

- Complex 3D tumor motion within the lung
- Sub-millimeter accuracy and reproducibility
- Motion software enables different cycles, amplitudes and wave forms
- Tissue equivalent from 50 keV to 15 MeV
- Compatible with TLD, MOSFET, Dose Gel, micro-chamber, NanoDot OSL, PET/ CT targets and film.
- Surrogate breathing platform accommodates numerous gating devices

CIRS

Overview

The CIRS Dynamic Thorax Phantom is a precision instrument for investigating and minimizing the impact of tumor motion inside the lung. It provides known, accurate and repeatable three-dimensional target motion inside a tissue equivalent phantom. It is designed for comprehensive analysis of image acquisition, planning and dose delivery in image-guided radiation therapy.

The phantom body represents an average human thorax in shape, proportion and composition. A lung equivalent rod containing a spherical target and or various detectors is inserted into the lung equivalent lobe of the phantom. The body is connected to a motion actuator box that induces three-dimensional target motion through linear translation and rotation of the lung equivalent rod. Motion of the rod itself is radiographically invisible due to its matching density with the surrounding material. The target and its motion, given its density difference, can be resolved.

Target and surrogate motion are independently controlled with CIRS Motion Control Software. The graphical user interface provides an unlimited variety of motions while simplifying the operation of the Dynamic Thorax Phantom to an intuitive level.

The Dynamic Thorax Phantom offers ease of use and portability as well as a flexible selection of motion profiles and dosimeter options. All components are packaged in a protective case. The system requires minimal set-up and can be ready to use in minutes. The CIRS Model 008A Dynamic Thorax Phantom presents a sophisticated solution for the complex challenges and emerging technologies in Image-Guided Radiation Therapy.

Computerized Imaging Reference Systems, Inc is recognized world wide for tissue simulation technology and is the leader in the manufacture of phantoms and simulators for medical imaging and radiotherapy.

www.cirsinc.com

Easy To Use Software

Dynamic Phantom Motion Control Selection (Thorax or Pelvis)

Graphical user interface simplifies operation of the Model 008A

Adjust motion amplitude, cycle time and phase shift with pull down menus and slider bars

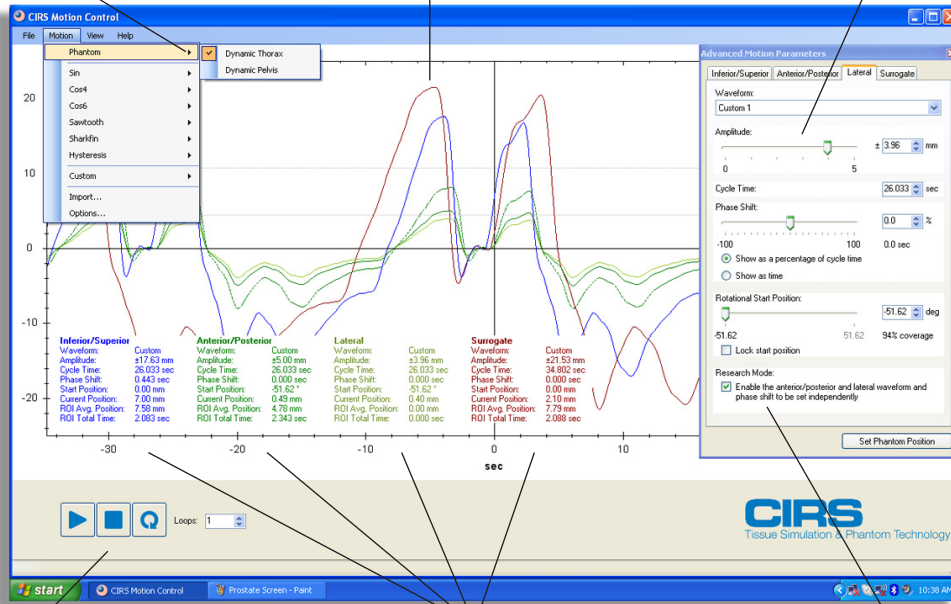

Instantly Start, Stop, Pause or Loop motion

Real-time display of target and surrogate motion parameters

Research Mode to import 3D recorded waveforms

USER FRIENDLY MOTION CONTROL

The Dynamic Thorax Phantom is operated using CIRS Motion Control Software Suite, a user-friendly graphical user interface that can be installed on any computer running Windows OS. Upon installation, the user has the option to select the phantom that is to be controlled by the software.

Amplitude, cycle time and phase shift can be applied to both the surrogate and main phantom using slider bars or by entering desired values within the limits of the system. Five different waveforms are available from a standard pull down menu.

An unlimited number of clinically relevant and patient specific waveforms or correlation models can be imported from tab delimited or comma separated file formats, including all main brand name tracking devices available on the market.

There are also waveform editing, smoothing and analyzing tools to ease the optimization of custom waveforms. All motion files can be saved for future use.

The software provides a convenient, real-time graphic display with relevant information about the waveform selected for each direction of simulated tumor. In addition the ROI analyzing function provides the time spent by the target between two chosen amplitudes and the average time weighted position for that particular ROI.

Users can instantly start, stop or pause the motion at any time. New start positions can be graphically selected and applied making the device very useful for static test as well as dynamic testing. Users can also select the number of cycles to be looped by entering the desired value or choose continuous looping (1 million cycles).

The Advanced Motion Parameters window contains a Research Mode that allows researchers to import 3D (x, y, z) recorded waveforms. Once the research mode is selected, the software automatically calculates the best scenario to simulate the real 3D waveform and simulated volume is achieved.

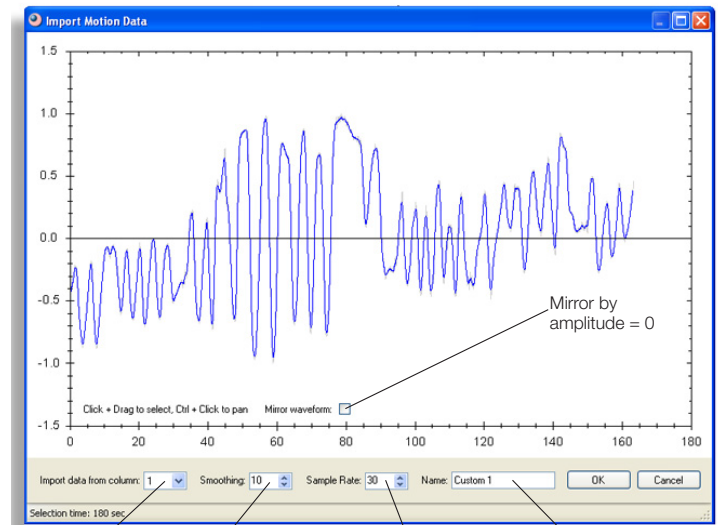

Data Column Selection

Smoothing (Un-smoothed Data = 0; Maximum Smoothing Degree = 100)

Sampling rate of recorded data by Motion Control Software (Used to reconstruct waveform) Range 1 to 100

Name of imported waveform (User or software assigned)

True 3D Target Motion In A Solid Epoxy Phantom

A lung-equivalent solid epoxy rod containing a soft tissue target (and/or dosimeter) is moved within a lobe of similar lung equivalent material in a solid phantom body. Motion of the lung material is radiographically invisible due to its matching density with the surrounding material, however the target can be resolved given its density difference.

The center of the target is positioned off central axis of the rod.

Complex 3D motions can be achieved thru simultaneous, independently controlled linear translation and rotation.

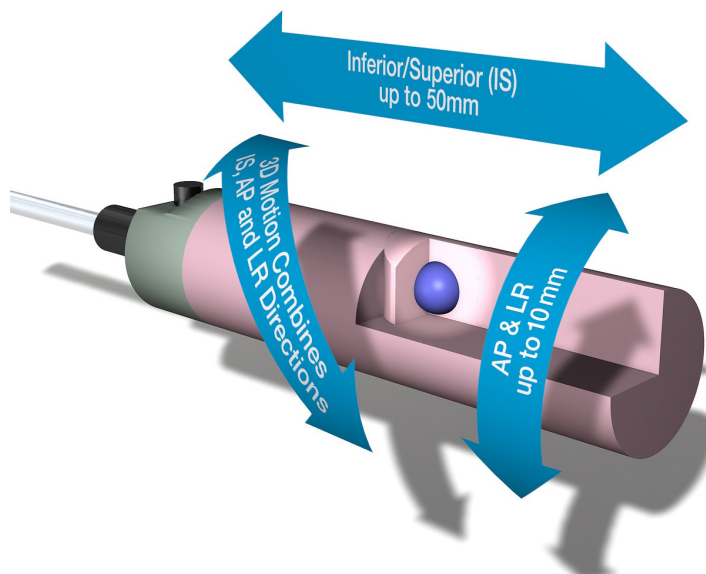
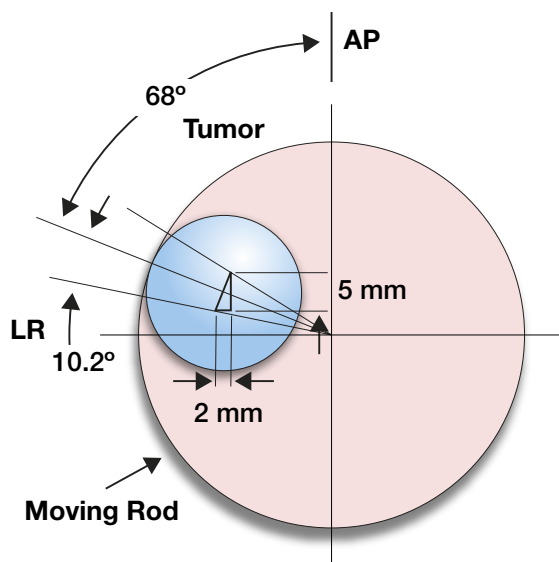

Within the CIRS Motion Control software, the user inputs desired range of target motion in the inferior-superior (IS), anterior-posterior (AP) and the left/right (LR) directions. Using these inputs, the software computes the rotational angles based on known distance of the target center relative to the central axis of the rod. Rotation instruction is sent to the actuator by the software.

- Maximum IS motion is 50 mm
- Maximum AP/LR motion is 10 mm via rotation
- Minimum cycle time is 1 second
- Maximum cycle time is unlimited

Independently Controlled Surrogate Motion

The surrogate motion is mechanically independent of tumor motion and programmable through the CIRS Motion Control Software. The surrogate platform can emulate either chest wall or diaphragmatic motion by manually changing its position. Various gating devices can be attached to the platform. The platform thickness and density allows for CT simulation of the diaphragm. This feature provides even greater

flexibility to the clinician and is useful in assessing correlation between surrogate and tumor motion.

- Maximum surrogate motion 50 mm
- Minimum cycle time is 1 second
- Maximum cycle time is unlimited

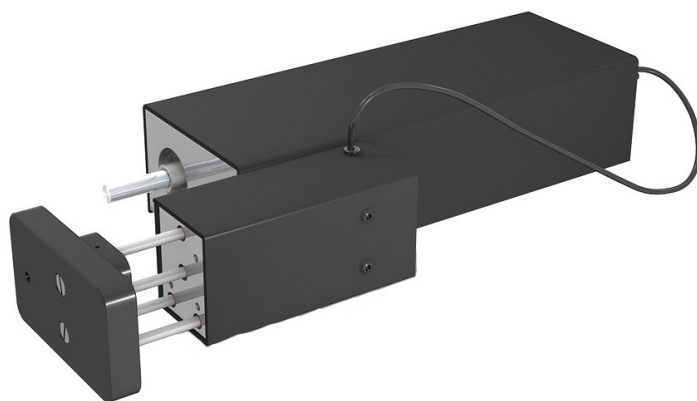
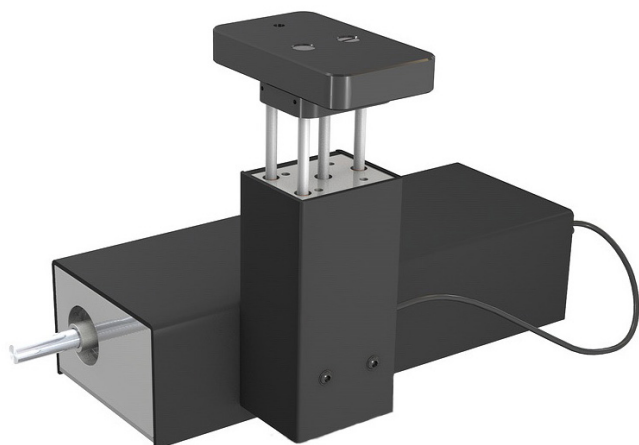

Proven Tissue Equivalent Phantom Technology

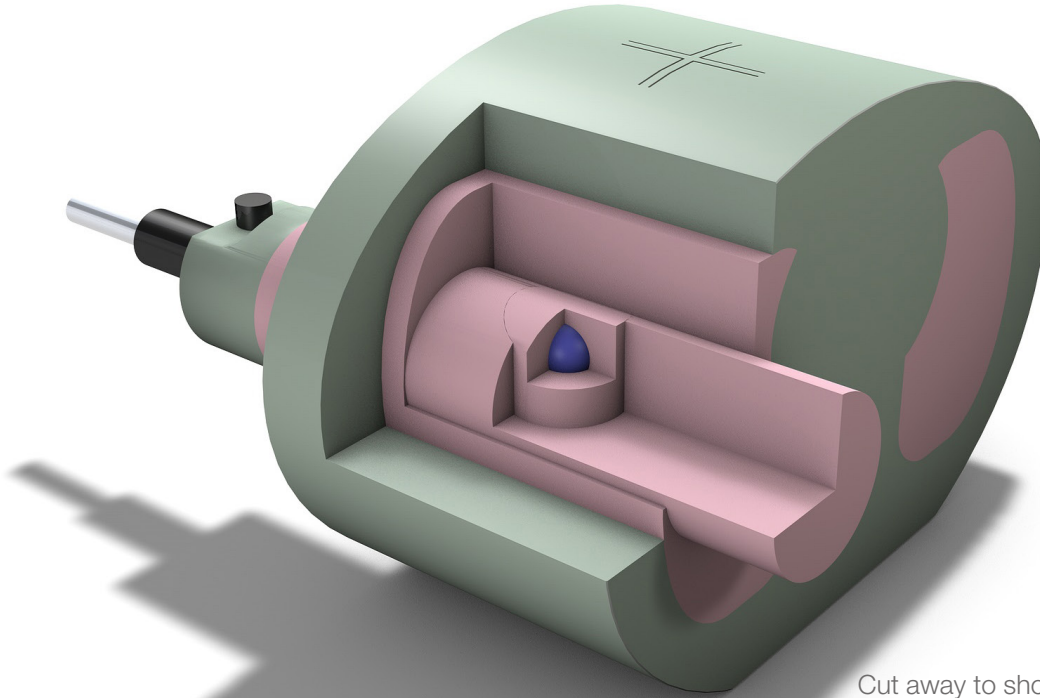

Cut away to show target location

The phantom body approximates the average human thorax in both size and structure using simplified geometries. It is constructed of proprietary tissue equivalent epoxy materials. Linear attenuations of the simulated tissues are within 1% of actual attenuation for water and bone, and within 3% for lung from 50 keV to 15 MeV.

Material	Density, g/cc	Electron Density x 10 ²³ , per cc	Ratio to H ₂ O
Plastic Water® DT	1.04	3.35	1.003
Lung	0.21	0.69	0.207
Cortical Bone	1.91	5.95	1.782
Trabecular Bone	1.20	3.86	1.156
Soft tissue target	1.06	3.43	1.028

Linear Attenuation Coefficients To Reference Tissues ^{(1) (2)}				
	Plastic Water® DT	Trabecular Bone	Cortical Bone	Lung (Inhale)
En, MeV	Ratio, %	Ratio, %	Ratio, %	Ratio, %
0.05	100.8	100.0	100.00	100.3
0.06	100.5	100.1	100.00	101.1
0.08	100.3	100.3	99.99	101.9
0.10	100.2	100.3	99.99	102.2
0.15	100.0	100.4	100.0	102.5
0.20	100.1	100.5	99.99	102.5
0.40	100.1	100.5	100.0	102.7
0.60	100.1	100.5	100.0	102.6
0.80	100.1	100.4	100.0	102.7
1.00	100.1	100.5	100.0	102.7
1.50	100.1	100.5	100.0	102.7
2.00	100.1	100.5	99.99	102.6
4.00	100.0	100.5	99.92	102.1
6.00	99.8	100.3	99.85	101.6
8.00	99.7	100.0	99.79	101.2
10.0	99.6	100.0	99.73	100.7
15.0	99.2	99.78	99.61	100.0
20.0	99.1	99.58	99.55	102.7

For internal landmarks, the phantom contains a 3D anthropomorphic spine with cortical and trabecular bone. External alignment marks with embedded fiducials facilitate rapid orientation with positioning lasers and phantom image registration.

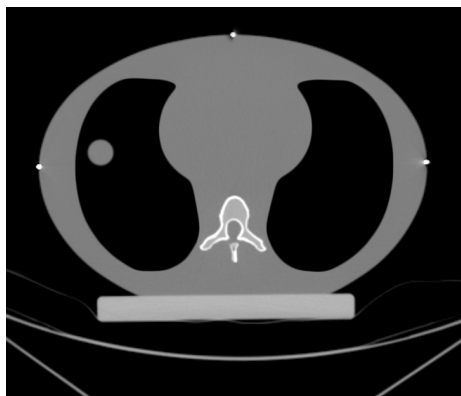

Tissue equivalent phantom body with anthropomorphic spine, external alignment marks and CT fiducials for phantom image registration

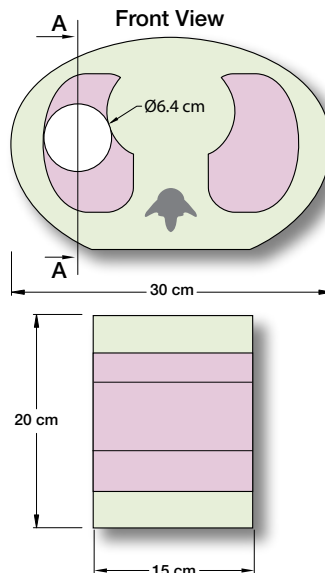

- ICRP 23, Report of the Task Group on Reference Man (1975).
- Woodard, H.Q., White, D.R., *The Composition of Body Tissues*, The British Journal of Radiology (1986) 59: 1209-1219

Interchangeable Inserts for QA & Dosimetry

There are ten interchangeable rods available for use with the phantom. Eight are made from lung equivalent epoxy and all measure 63.5 mm in diameter. The lung equivalent inserts accommodate either MOSFET, micro chamber, film, nanoDot™ OSL, PET/CT targets, or gel dosimeters. The rods are easily connected and aligned to the drive shaft. All rods can be quickly interchanged.

The MOSFET, micro chamber, and SBRT inserts are designed for target acquisition and quantitative dose measurements. Each rod includes a 1, 2 and 3 cm soft-tissue equivalent target insert. Each insert is machined to receive the dosimeter at the center of the target volume.

The imaging insert is designed to provide solid known diameter targets for imaging applications and includes a 1, 2 and 3 cm soft-tissue equivalent target insert.

The Radiochromic film insert holds a single 135 X 55 mm film at midplane along the long axis. The homogeneous rod has 3 fiducials that are radiographically visible and enable film to plan registration. The rod is drilled to allow indentation of the film relative to the implanted fiducials.

The Ball Cube Film insert contains a 25.4 mm diameter spherical target that accommodates two pre-cut Radiochromic films. Volume of target is 8.58cm³ if film is taken into account and 8.28cm³ (4x 2.07cm³ quadrants) if film is not accounted for.

The gel insert receives a standard B9 dose gel container. The container is made from oxygen resistant plastic. Clear walls enable visual inspection of the irradiated gel. The container can be scanned in CT, MRI and optical laser scanners.

The PET/CT target insert includes hollow spheres of known volume that can be filled with 0.5, 2 and 8 ml of radionuclides to simulate cold or hot spherical "lesions".

The 4D CT QA insert option provides a quantitative quality control method for the 4D CT scanner's image binning function. The 4D CT QA device consists of an acrylic tube with static fiducials in a grid pattern and a moving rod with a single fiducial. The motion of the single fiducial is set-up to match positions of the static fiducials on the acrylic tube at the maximum inhale and maximum exhale phases of the breathing cycle. Using the 4D CT QA insert, users can optimize safety margins during treatment planning of moving tumors by identifying misalignments in 4D CT binning as small as 0.5 mm. The maximum displacement is 30 mm in IS direction and 20 mm in both AP and LR directions. The moving cylinder can also be used to investigate artifacts, volumes, and shapes during different breathing motions, including patient-specific motion profiles because of it's regular size and cylindrical shape.

MOSFET INSERT Model 008A-05

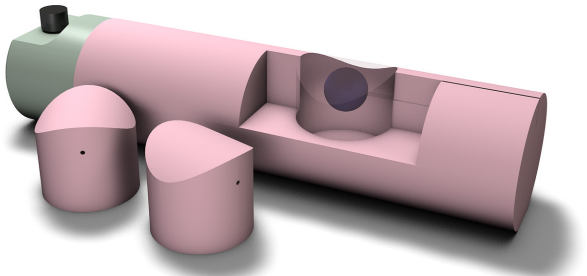

(Cutaway to show internal structure of rods)

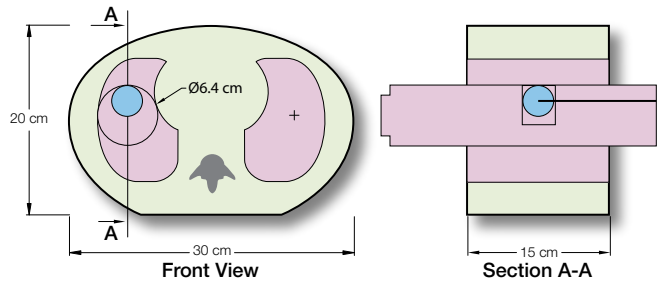

MICRO CHAMBER INSERT Model 008A-06-CV**

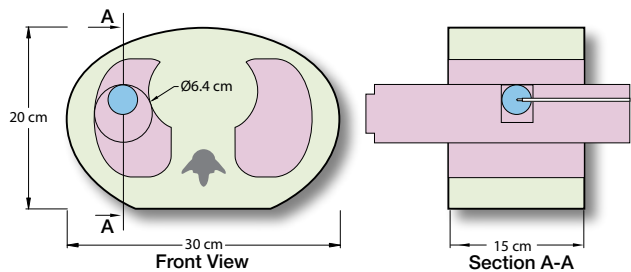
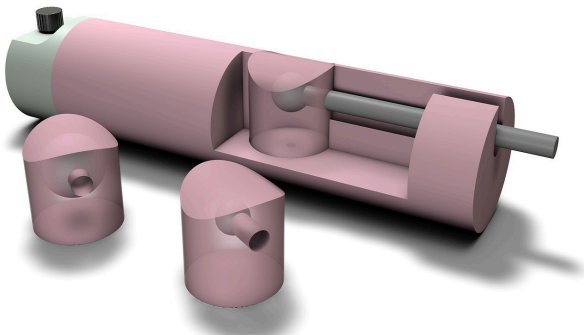

IMAGING INSERT Model 008A-14

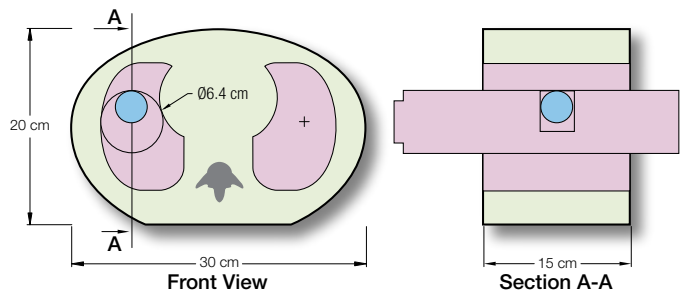
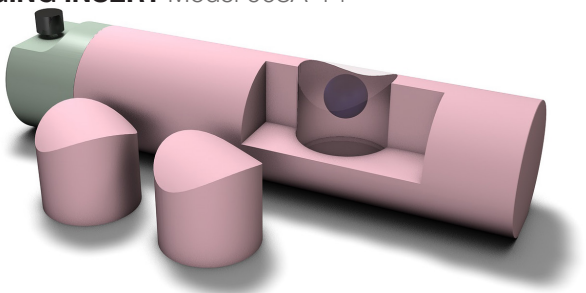

RADIOCHROMIC FILM INSERT Model 008A-08

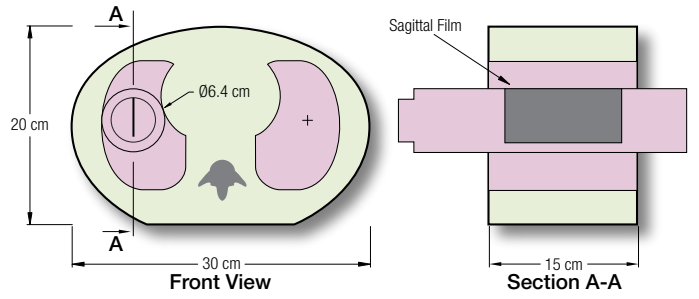
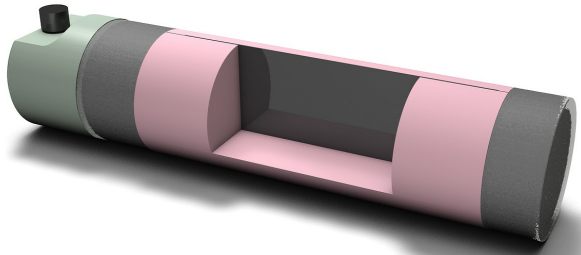

BALL CUBE FILM INSERT Model 008A-19

*Ball cube film sold separately. Contact your local Ashland distributor for more information.

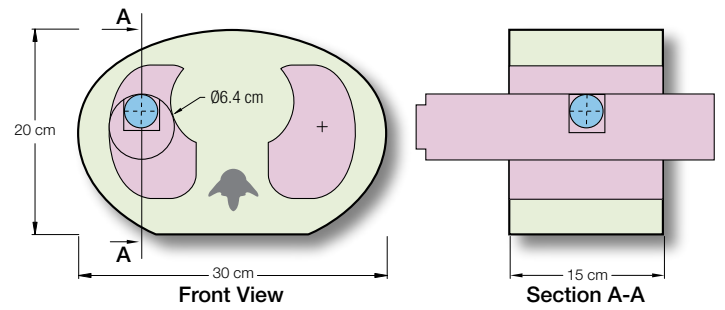
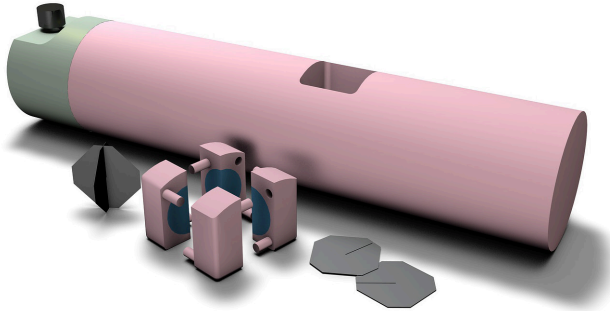

GEL DOSIMETRY INSERT Model 008A-11

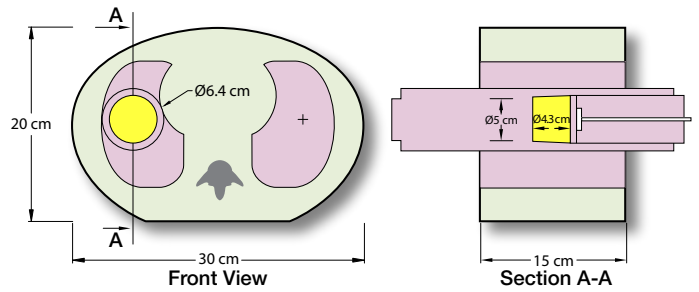
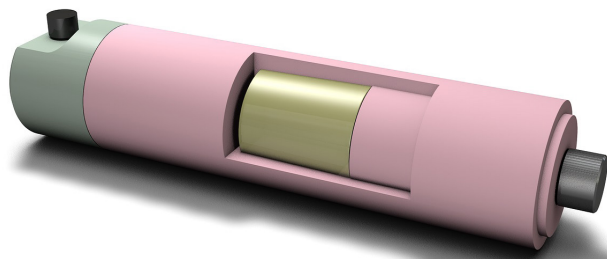

PET/CT INSERT Model 008A-15

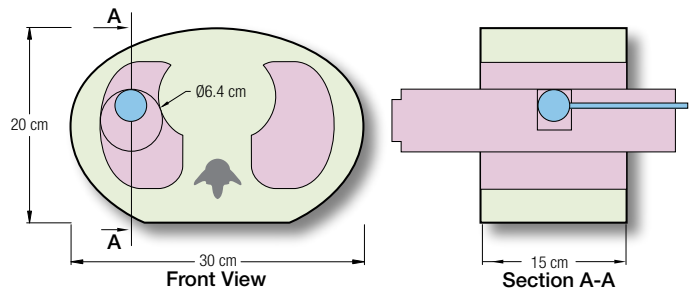
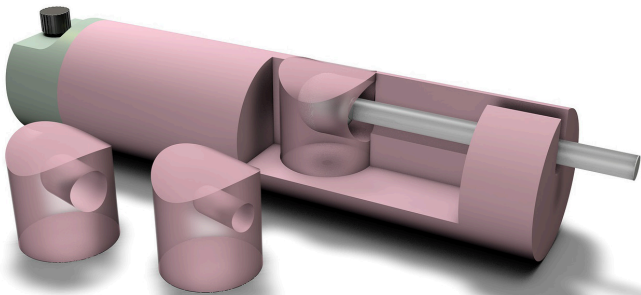

4D CT QA INSERT Model 008A-12

US Patent # 7699522 B2

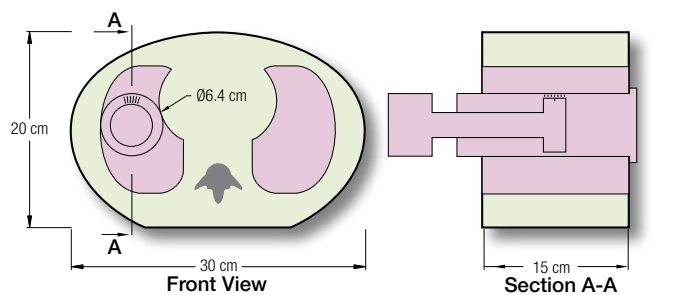
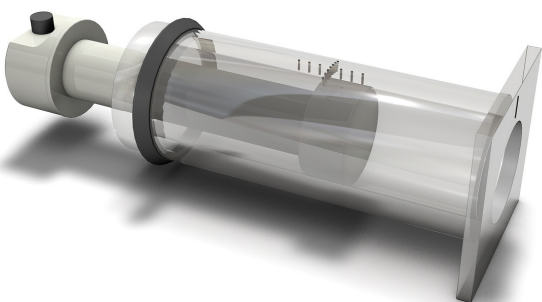

Interchangeable Inserts for QA & Dosimetry

SBRT Rod Model 008A-22

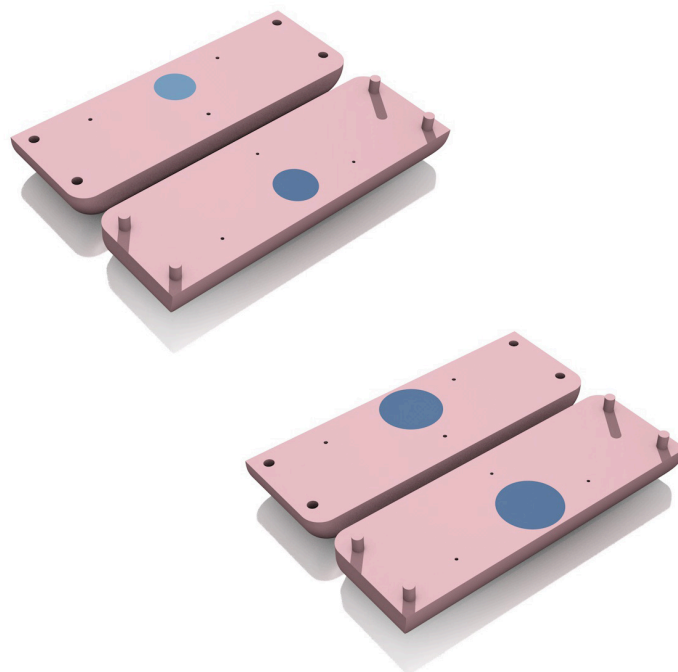
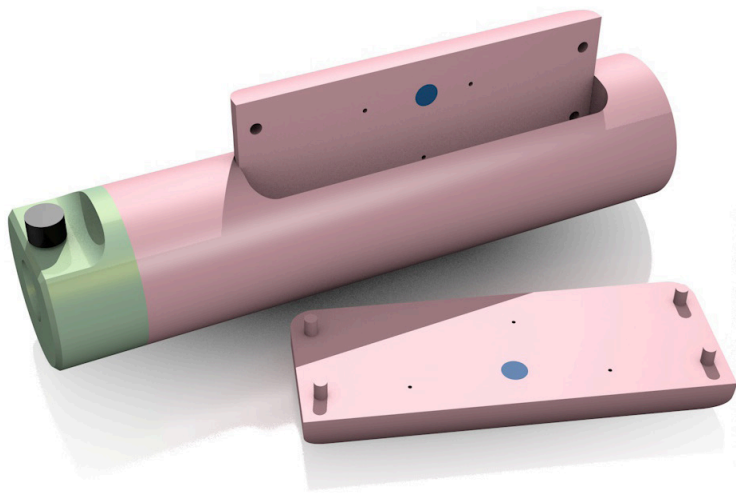

The SBRT Insert contains a milled cavity that accommodates three interchangeable film inserts. Each insert contains an embedded spherical soft tissue target, respectively 1 cm, 2 cm, and 3 cm diameter.

Targets are positioned within inserts so the isocenter is at 15 mm from longitudinal axis of rotation of SBRT insert to enable AP and LAT motion.

Film inserts hold a single 140 X 54 mm film at mid-plane along the long axis. One half of each film insert has 3 fiducials that are radiographically

visible and enable film to plan registration.

The other half of each film insert is drilled to allow indentation of the film relative to the implanted fiducials. All sides and bottom edges of the inserts are rounded with different radiuses for unique match with SBRT rod cavity.

OSL Dosimetry Rod with 3 cm Target Insert Model 008A-24

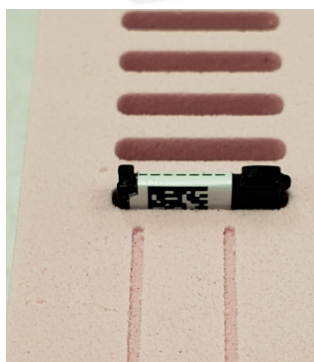
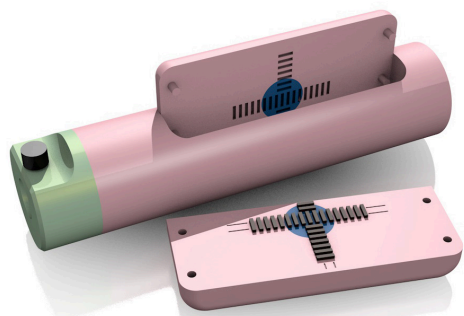

The OSL Dosimetry 3 cm Target Insert (Model 008A-24) accommodates 24 nanoDot™ OSL dosimeters for measurements inside a soft-tissue target and in the penumbra.

The insert is split in two parts of different thicknesses to allow the positioning of nanoDot™* ISO centers in a mid-plane that goes through the center of the 3 cm target and the mid-plane of the rod.

The nanoDot™ pockets are machined 4.1 mm apart along two perpendicular axes to allow measurements in both sagittal and coronal planes.

The insert has one interior flat face engraved with lines that correspond with the size of the 2D bar codes, which are applied by nanoDot™ OSL dosimeters' manufacturer. For proper alignment between nanoDot™ ISO centers and target center, nanoDot dosimeters should be inserted into the pockets aligning the 2D bar codes with these engraved marks.

*NanoDot® is a trademark of Landauer (Glenwood, IL)

Advanced Electromechanical Components

ACTUATOR

Housed within anodized aluminum enclosures, the actuator contains bipolar stepper motors that enable linear motion accuracy of 0.05 mm and rotational motion accuracy of 0.2°. Linear motion of the target in the (IS) direction can be isolated from rotational motion in the axial plane in both frequency and amplitude. Surrogate motion is independently controlled. Motions can be synchronized to one another with accuracy better than 20 msec. Motion cycle time accuracy is better than 5 msec. Optical sensors ensure precise mechanical positioning. The actuator is designed for continuous operation. If not manually stopped and reset by the user, it will perform 1000000 (in continuous mode) cycles then stop automatically.

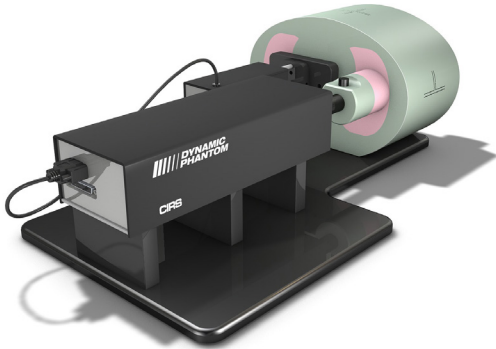

CONTROLLER

Motions are generated through a three-axis motion controller. A USB port enables interfacing with most computers. The controller sends instructions as well as supplies and conditions power to the actuator thru a 25 pin serial cable.

The motion controller can be fully operated through CIRS Motion Control Software (see page 3) from a distance of up to 70 feet with the Ethernet/USB cable provided.



ADJUSTABLE LEGS

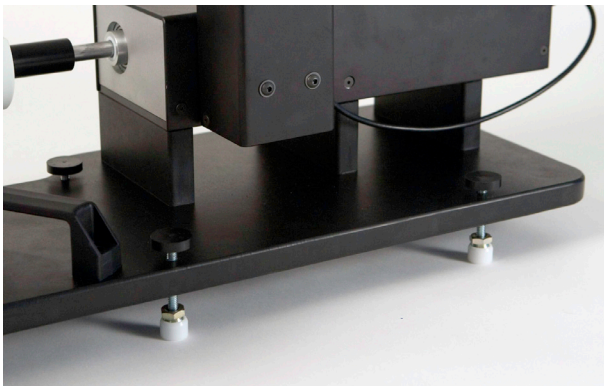

Adjustable legs can be useful in leveling the phantom on curved imaging couches.

Additional Options

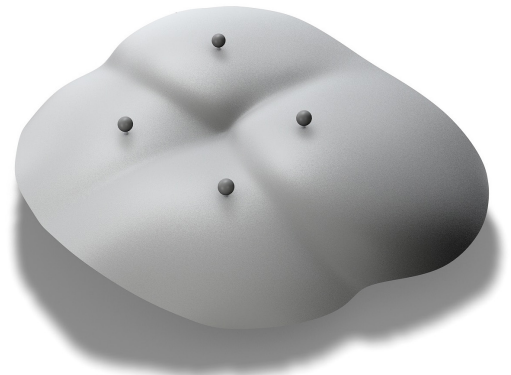

The optional chest plate can be useful for collecting chest motion and breathing data using optical tracking systems.

Model 008A Specifications

Overall Dimensions:	67 cm x 32 cm x 28 cm (26" x 15" x 11")
Overall Weight:	17.2 kg (37.9 lb)
Power:	110-250 VAC, 50/60 Hz
Amplitude, IS:	± 25 mm
Amplitude, AP/LR:	± 5 mm
Amplitude, Surrogate:	± 25 mm
Max. Surrogate Platform Load	5.4 kg (12 lb)
Motion Accuracy:	± 0.1 mm
Cycle Time:	1 - ∞ (adjusted based on amplitude)
Waveforms:	sin (t), 1-2cos4(t), 1-2cos6(t), sawtooth, sharkfin
CIRS Motion Control Software System Requirements	Windows XP® or later (32 or 64 bit) Pentium 3® or equivalent 512 MB RAM 2 MB of available disk space

INCLUDED WITH MODEL 008A

Part No.		Component Description
008A	1	Dynamic Thorax Phantom Body with 3D spine (Dosimeter & QA rods not included)
	1	Dynamic Motion Controller with firmware installed (110 - 220V, 50 - 60Hz)
	1	Actuator base plate assembly
	1	3rd axis gating device (mounted to actuator base plate assembly)
	1	CIRS Motion Control Software USB
	1	Cable kit: USB 3.0 Gigabit Ethernet Adapter, Network cable CAT5e, 75', DB 25 male to male cable, DB 9 male to male cable, Power cord
	1	Accessories Kit: 4 in 1 screwdriver, push rod, fasteners pack, 2 spare fuses
	1	Adjustable legs kit: level, 4 adjustable legs with feet, post with screw
	1	User's guide (PDF user guide and catalog included on provided USB)
	1	Carry Case

Upgrade Program (Motion Controller)

CIRS Dynamic Phantoms with motion controller box that communicates with the PC through USB and consists of a "P136" SN, experience PC communication failure and must be upgraded to a new motion controller.

The upgrade will provide users with:

- Exchange of motion controller to communicate with the PC through ethernet using static IP address.
- CIRS Motion Control Software
- USB to network adapter along with driver
- Mounting and connecting surrogate motion platform on motion actuator
- Minor hardware upgrade
- Cleaning and testing of all components

Users must return the entire system to CIRS. Contact CIRS to receive pricing and an RMA number.

Ordering Information

OPTIONAL ACCESSORIES

Note: Customers must complete their order with the purchase of at least one (1) interchangeable insert option. *Refer to separate CIRS cavity and plug code list for available chamber cavities.

Part No.	Description
008A-05	MOSFET configured lung equivalent rod with set of 3 target inserts
008A-06-CV*	MICRO CHAMBER configured lung equivalent rod with set of 3 target inserts
008A-08	Radiochromic film configured lung equivalent rod
008A-11	GEL DOSIMETRY configured lung equivalent rod with CIRS Model B-9, Dose Gel Container
008A-12	4D CT QA Device
008A-14	Lung equivalent Imaging Rod with set of 3 target inserts
008A-15	PET/CT configured lung equivalent rod with set of 3 target inserts
008A-17	Adjustable legs kit
008A-19*	Ball Cube configured lung equivalent rod for film dosimetry*
008A-22	SBRT Rod with set of 3 target inserts
008A-24	OSL Dosimetry Rod with 3 cm Target insert
008A-153	Replacement Push Rod
008A-125	Chest plate with reflective 11.5 mm tracker balls
008-18	Model 008 upgrade to 008A
008A-253	Cable CAT5E 150 Feet for Dynamic Phantom (008A, 008M,)
158200-26	Precision Cut EBT3 Film Kit for Model 008A-08 (Set of 12 inserts plus 6 calibration strips)
158200-27	Precision Cut EBT3 Film Kit for Model 008A-22 (Set of 12 inserts plus 6 calibration strips)

*Ball cube film sold separately. Contact your local Ashland distributor for more information.

Upgrade Program (Phantoms)

The original Model 008 Dynamic Thorax Phantom can be upgraded to the Model 008A. The Model 008 featured surrogate motion that was coupled to the tumor motion. The upgrade will provide users with independently programmable surrogate motion and Motion Control Software that allows unlimited variety of motion profiles including easy download of patient specific motions.

The upgrade will provide users with:

- Exchange of 008 2 axis Controller with 008A 3 axis Dynamic Motion Controller
- CIRS Motion Control Software
- Surrogate motion platform
- Mounting and connecting surrogate motion platform on motion actuator
- Minor hardware upgrade
- Cleaning and testing of all components

Users must return the entire system to CIRS. Contact CIRS to receive pricing and an RMA number.

LIMITED WARRANTY

All standard CIRS products and accessories are warranted by CIRS against defects in material and workmanship for a period as specified below. During the warranty period, the manufacturer will repair or, at its option, replace, at no charge, a product containing such defect provided it is returned, transportation prepaid, to the manufacturer. Products repaired in warranty will be returned transportation prepaid.

There are no warranties, expressed or implied, including without limitation any implied warranty of merchantability or fitness, which extend beyond the description on the face hereof. This expressed warranty excludes coverage of, and does not provide relief for, incidental or consequential damages of any kind or nature, including but not limited to loss of use, loss of sales or inconvenience. The exclusive remedy of the purchaser is limited to repair, recalibration, or replacement of the product at manufacturer's option.

This warranty does not apply if the product, as determined by the manufacturer, is defective because of normal wear, accident, misuse, or modification.

Non-Warranty Service

If repairs or replacement not covered by this warranty are required, a repair estimate will be submitted for approval before proceeding with said repair or replacement.

PRODUCT	WARRANTY PERIOD
Models 008A, 18023-A & 18043-A-Dynamic Phantoms	24 Months

REFERENCES:

Munoz, C., et al., Evaluation of Positional Accuracy in Moving Tumors Using a CIRS Dynamic Phantom. Poster presented, Cyberknife User's Meeting January 2007.

Tanyi, James, A., et al., Phantom investigation of 3D motion-dependent volume aliasing during CT simulation for radiation therapy planning. *Radiation Oncology*, 2007, 2:10.

Wang, Z., et al., Verifying Internal Target Volume using Cone-Beam CT for Stereotactic Body Radiotherapy Treatment. 2006 AAPM Abstract ID No. 5263, Poster #: SU-EE-A1-4.

Tanyi, James, A., et al., Dosimetric Evaluation of Target Dose in Stereotactic Body Radiation Therapy (SBRT) of Lung Lesions Using a Dynamic Motion Anthropomorphic Phantom. 2004 AAPM PO-T-143 Poster.

Tanyi, James, A., et al., Phantom Investigation of Three-Dimensional, Motion-Induced Dose Discrepancy During Intensity Modulated Radiation Therapy Dose Delivery. Poster presented at 2006 annual AAPM meeting, Orlando FL, July 2006.

Tanyi, James, A., et al., Phantom Investigation of Three-Dimensional Motion Dependent Volume Aliasing During CT Simulation for Radiation Therapy Planning. Poster presented at 2006 annual AAPM meeting, Orlando FL, July 2006.

Varchena, V., et al., A novel Dynamic Thorax phantom for 3D-CRT and IMRT of lung lesions. *Radiotherapy & Oncology at Meeting*, Vol. 76, Supplement 2, September 2005.



**COMPUTERIZED IMAGING
REFERENCE SYSTEMS, INC.**

900 Asbury Ave
Norfolk, Virginia 23513 USA

Toll Free: 800.617.1177

Tel: 757.855.2765

Fax: 757.857.0523

E-mail admin@circsinc.com

www.cirsinc.com

Technical Assistance

1.800.617.1177



Computerized Imaging Reference Systems, Inc. has
been certified by UL DQS Inc. to **(ISO) 13485:2016**.
Certificate Registration No. 10000905-MP2016.

©2013 Computerized Imaging Reference Systems, Inc. All rights
reserved. All brand names, product names or trademarks belong
to their respective holders.
Specifications subject to change without notice.
Publication: 008A PB 082521