



Solutions Portfolio

Diagnostic Imaging QA 2023



SUN NUCLEAR
A MIRION MEDICAL COMPANY



Better Quality Management. Better Care.

Sun Nuclear provides the broadest range of advanced Patient Safety solutions.

CT

CT ACR 464 Phantom	6
CT ACR 464 Phantom Accessories.....	6
IQphan™	7
Advanced iqModules™	8
Multi-Energy CT Phantom	9
Advanced Electron Density Phantom	10
RapidCHECK™ Software	11
Mercury 4.0 Phantom	11
Large Field MR Image Distortion Phantom	12
MR Distortion & Image Fusion Head Phantom	13
CT Perfusion Phantom.....	14
CTDI Phantoms	15
Electron Density Phantom.....	15

Ultrasound

Doppler 403™ Flow & Mini-Doppler 1430™ Flow Phantoms.....	16
Doppler Flow Pump	17
Doppler Ultrasound Flow Phantom.....	17
Sono403™ Phantom.....	18
Multi-Purpose Ultrasound Phantoms	19
General Purpose Ultrasound Phantom.....	20
SonoTE™ Phantom & CIRS Model 551	20
3D Ultrasound Calibration Phantom	21
Beam Profile & Slice Thickness Phantom.....	21
Sono408™ Phantom.....	22
Sono405™ Phantom.....	23
Brachytherapy QA Phantom.....	24
3D Calibration Phantom.....	24
Invenia ABUS Phantom	25
General & Small Parts Phantom	25
Sono404™ Phantom.....	26
Small Parts Phantom	27

Mammography

Mammo FFDM™ Phantom.....	28
Mammo 3D™ Performance Kit.....	28
Mammo 156™ Phantom.....	29
Mammo 156D™ Phantom.....	29
Contrast Enhanced Spectral Mammography Phantom.....	30
Mammo CESM™ Phantom	30
Digital Breast Tomosynthesis QC Phantom	31
Stereotactic Needle Biopsy Phantom.....	32
Ultrasound Needle Breast Biopsy with Amorphous Lesions	32
Multi-Modality Breast Biopsy and Sonographic Trainer.....	32
Mammo Digital Compression Device.....	33
Phototimer Consistency Tools.....	33
Mammo Film Screen Contact Test Tool.....	33

DR/CR/Fluoroscopy

Aluminum Step Wedge.....	34
Signal Difference to Noise Ratio (SDNR) Set....	34
Beam Alignment Test Tool	34
Collimator Alignment Test Tool	35
Grid Alignment Test Tool	35
Half Value Layer (HVL) Attenuator Sets	35
Fluoroscopic Dose Rate and Low Contrast Resolution Test Tool Kit.....	36
DR QC Phantom	36
Radiographic Aluminum Stepwedge, 11 Steps (117)	36
Half Value Layer Attenuator Set, Pure Copper (116)	36
High Contrast Resolution Test Tool	37
Half Value Layer Attenuator Set, Copper Alloy 110	37
Contrast Detail Tool	37
Radiography Fluoroscopy QA Phantom	37
Ultra Star Test Pattern (1-360°) & Ultra Star Test Pattern (4-15°)	39
Focal Spot Test Tool.....	38
Anthropomorphic Neo-Natal Chest Phantom ..	38
Universal Test Stand (175).....	38
Resolution Test Pattern, 0.6-5.0 bar, 20 groups	39
Resolution Test Pattern, 5.0-20 LP/mm, 16 groups	39
Resolution Test Pattern, 1 sector	39
Resolution Test Pattern, 0.5-4.86 LP/mm bar, 16 groups	39

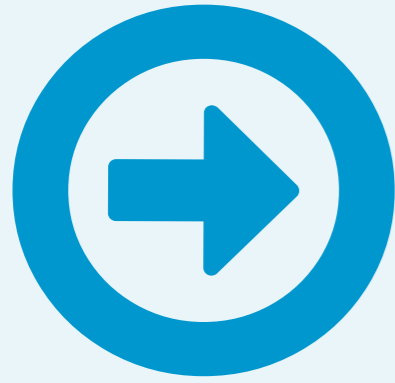

Trusted.

Hospitals & clinics worldwide choose Sun Nuclear.

Linac manufacturers, imaging manufacturers, researchers, and scientific associations leverage Sun Nuclear solutions routinely, too. Collectively, the fields of Radiation Therapy and Diagnostic Imaging count on us to help:

- Mitigate errors
- Reduce inefficiencies
- Validate technologies and techniques
- Elevate clinical care

Through nearly 40 years of service, we have come to know Quality Management from all angles — and we're proud of the unique role we play in protecting Patient Safety.

Today, Sun Nuclear is stronger than ever. We are the cornerstone of Mirion Medical, a growing division within Mirion Technologies. In addition, we are actively integrating CIRS solutions into our broader portfolio, to optimize offerings for every clinic.

Our New Logo

With the formation of the Mirion Medical group, you will begin to notice some changes for Sun Nuclear and CIRS. This includes increased use of a new Sun Nuclear logo, and integration of CIRS solutions into the Sun Nuclear brand.

During this transition, you may receive a mix of branding on your products and accessories. Rest assured, regardless of the logo, your products have been manufactured with the utmost attention to quality and will receive the same exceptional level of service you have come to expect from us.



130+
Countries with Sun Nuclear Solutions

5,000+
Worldwide Cancer Treatment Facilities Use Sun Nuclear Solutions

>90%
of U.S. Cancer Treatment Centers Use Sun Nuclear Solutions

20+
Countries with SunServices™ Team Member Representation

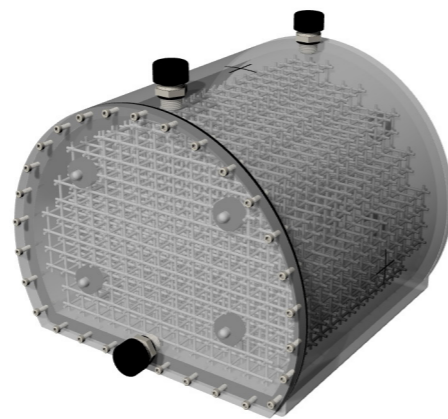
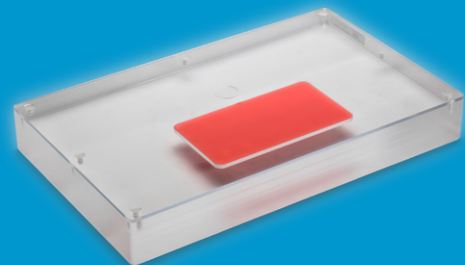

CT ACR 464 Phantom

Multi-Modality CT Accreditation

PN 804740, Stand (PN 804868) sold separately



Comprehensive CT Testing

- Test positioning and alignment accuracy, CT number accuracy, slice thickness, low contrast detectability, image resolution and uniformity, spatial resolution, and inter- and intra-plane distance measurement accuracy
- Meet AAPM TG-66 requirements

Proven & Versatile Design

- Made of the original Solid Water® Zero HU formulation
- Works with **RapidCHECK™** software to automate CT image quality testing
- Optional Phantom Body Ring and Extensions available

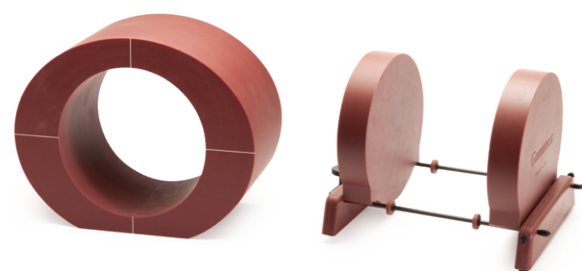

CT ACR 464 Phantom Accessories

Body Ring, Extensions & Cases

PN 805384 (Body Ring), PN 805558 (Extension Kit)

Material	Zero HU CT Solid Water®
Inner Diameter	20 cm
Depth	61 cm
Outer Diameter	33 cm wide, 26.4 cm high
CT ACR 464 Phantom Extension Kit	
Material	Zero HU CT Solid Water®
Plate Thickness	4.0 cm (1.6 in)
Diameter	20 cm (7.9 in)

Specifications

Material	Zero HU Solid Water®
Diameter	20.0 cm (7.9 in)
Length	16.0 cm (6.3 in)
Weight	5.3 kg (11.7 lbs)

Imbedded Test Objects

Water Equivalent Linearity Rod	Solid Water, Zero HU
Bone Equivalent Linearity Rod	Bone tissue equivalent material
Acrylic Linearity Rod	Cast Acrylic
Polyethylene Linearity Rod	Low Density Polyethylene
Low Contrast Rods	6 ±0.5 HU Contrast rods, in sizes ranging
Tungsten Carbide Beads	0.28 mm (0.011 in) in diameter grade
Line pair Material	6061 Aluminum and Polystyrene



Soft Case for CT ACR 464 Phantom & Stand

PN 804867



Soft Case for Extension Plate Kit

Fits Extension Stand & 2 End Plates/
Advanced iqModules™

PN 805540



Soft Case for CT ACR 464 Phantom & Extension

Fits CT ACR 464 Phantom, Extension Stand & 2 End Plates/Advanced iqModules™ Plate Kit

PN 805541

IQphan™

Comprehensive CT Image Quality Phantom

PN 806107

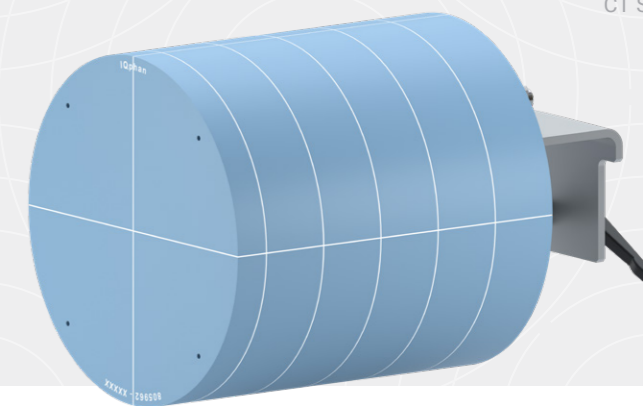

Comprehensive CT QA – All in One Phantom

- Perform QA across CT imaging systems, from sophisticated diagnostic scanners to cone beam to on-board radiotherapy systems
- Use with RapidCHECK™ Image Quality Analysis software for exacting CT imaging quality testing, with quick, consistent analysis
- Made from true tissue-mimicking HE CT Solid Water®

Modular Testing Support

- **High-Contrast Resolution Module** features high-resolution line pairs, large 3D patterns that are easy to visualize, and robust data analysis in the RapidCHECK software
- **Slice Thickness & Geometric Evaluation Module** with multiple wire-ramp materials and diameters enable analysis of slice thickness on range of scanners – from diagnostic CT to CBCT and MVCT
- **Low-Contrast Detectability Module** provides a low-contrast test covering radiation therapy systems and diagnostic CT
- **Uniformity Module** supports assessment of noise and uniformity in HE CT Solid Water
- **HU Module** tests the consistency of known HU materials and measures the effective energy of the scan.

High-Contrast Resolution Module Specifications

Material	HE CT Solid Water®
Diameter	20.0 cm (7.9 in)
Length	A 4.0 cm (1.57 in) measurement region plus 2.0 cm on the end for mounting and scatter equilibrium
Resolution Pattern Size	1.5 cm x 1.0 cm x 4.0 cm
Resolutions Tested	2,4,5,6,7,8,9,10,12,14,16,18,20,22 lp/cm
Automated Analysis	Solid material samples improve computational analysis
Features	Large 3D pattern sizes enable robust evaluation

Slice Thickness & Geometric Evaluation Module Specifications

Material	HE CT Solid Water®
Diameter	20.0 cm (7.9 in)
Wire Ramps	2x Tungsten wire, 0.15 mm diameter,
Geometric Evaluation	Four air holes, 125 mm apart
MTF BB's	1 - 0.18 mm; 2 - 0.28 mm
MTF Wire	Tungsten wire, 5 degrees off-vertical,
Acrylic Spheres	1.0, 1.5, 2.0, 3.0, 4.0, 6.0, 8.0, and 9.5

Low-Contrast Detectability Module Specifications

Material	Epoxy interior, with a shell of our new
Diameter	20.0 cm (7.9 in)
Length	4.0 cm (1.57in)
Resolution Pattern Size	0.3%(3HU),0.6%(6HU),1.0%(10HU), 2.0%
Resolutions Tested	2,3,4,5,7,9, 12, 15, and 25 mm
Automated Analysis	2, 3, 5, 7, and 10 mm (cylinder diameter)

Uniformity Module Specifications

Material	HE CT Solid Water®
Diameter	20.0 cm (7.9 in)
Length	4.0 cm (1.57in)

HU Module Specifications

Base Material	HE CT Solid Water®
Diameter	20.0 cm (7.9 in)
Length	4.0 cm (1.57in)
Insert Materials	2x HE CT Solid Water, HE Inner Bone,

Advanced iqModules™

Expanded Image Quality CT QA

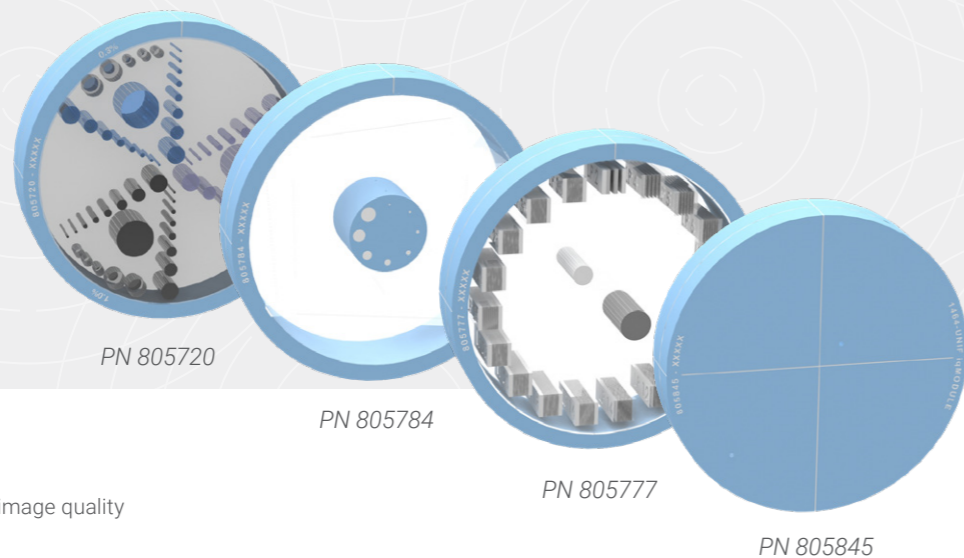

Unmatched Image Quality Testing

Set of four modules for comprehensive CT image quality testing

- **Low-Contrast Detectability Module** tests performance across scanners and protocols with three different contrast levels
- **Slice Sensitivity & Geometric Evaluation Module** validates slice thickness, sensitivity profile and system geometry
- **High-Contrast Resolution Module** expands CT ACR 464 testing
- **Uniformity Module** assess CT number uniformity

Modular CT QA Support

- Can be combined with **CT ACR 464, Advanced Electron Density, or Multi-Energy CT Phantoms**

All Advanced iqModule Specifications

Materials	Epoxy and CT High Equivalency Solid Water® (Uniformity Module comprised solely of HE CT Solid Water)
Diameter	20.0 cm (7.9 in)
Length	4.0 cm (1.57 in)
Warranty	5 years

Low-Contrast Detectability Module Specifications

Contrast Levels	0.3 % (3 HU), 0.6 % (6 HU), 1.0 % (10 HU)
Sizes at Each Contrast Level	25 mm, and two at each of 1.5, 2, 3, 4, 5, 7, 9, and 12 mm
Sizes of Sub-slice Objects	2, 3, 5, 7, and 10 mm (cylinder diameter and length), at each contrast level

High-Contrast Detectability Module Specifications

Resolution Pattern Size	1.5 cm x 1.0 cm x 4.0 cm
Resolutions Tested	2, 4, 5, 6, 7, 8, 9, 10, 12, 14, 16, 18, 20, 22, 24, 26, 28, 30 and 32 lp/cm
Automated Analysis Features	Solid material samples improve computational analysis. Large pattern sizes enable robust evaluation.
Contrast Material	Zinc

Slice Sensitivity & Geometric Evaluation Module Specifications

Wire Ramps	Tungsten wire, 0.05 mm diameter
Bead Ramps	One opposed set with 0.18 mm tungsten carbide BBs, and one with 0.28 mm tungsten carbide BBs
MTF BB's	0.18 mm and 0.28 mm
MTF Wire	Tungsten wire, 5 degrees off-vertical, 0.05 mm diameter
Acrylic Spheres	1.0, 1.5, 2.0, 3.0, 4.0, 6.0, 8.0, and 10.0 mm diameter

Uniformity Module Specifications

Tungsten Carbide Beads	0.28 mm (0.011 in) in diameter grade 25 Tungsten Carbide beads
------------------------	--

Multi-Energy CT Phantom

Comprehensive Testing, Tissue Equivalence

PN 805754



Comprehensive Testing of Scanner Performance

- Test efficacy of clinical protocols for multi-energy analysis
- Compare consistency and stability across scanners

Automated Material Discrimination

- Solid rods represent iodine, calcium, blood, adipose, and more
- Patented rod markers enable automated analysis
- Expanded range of testing to exceed draft AAPM Task Group 299 requirements

Specifications

In-Plane Dimensions	40.0 cm (15.7 in) x 30.0 cm (11.8 in)
Depth	16.5 cm (6.3 in), up to 26.5 cm (10.2 in) with extension plates
Removable Head Section Diameter	20.0 cm (7.87 in)
Material	HE CT Solid Water®
Interchangeable Inserts	27 solid inserts plus 1 true water container, each tagged with a CT visible rod identification code
8 Iodine Inserts with Variable Concentrations	Concentrations of 0.2, 0.5, 1.0, 2.0, 5.0, 10.0, 15.0, and 20.0 mg/mL
3 Iodine Inserts with Variable Diameters	5.0 mg/mL concentration at diameters of 2.0, 5.0, and 10.0 mm
8 HE Calcium Inserts with Variable Concentrations	Concentrations of 0, 5, 10, 20, 50, 100, 200, and 300 mg/mL
3 Blood [iron] Inserts	Blood-mimicking material at relative electron densities of 1.03, 1.07, and 1.10
2 Blood [iron] with Iodine Inserts	Blood-mimicking material plus iodine at 2.0 and 4.0 mg/mL
3 Tissue-Mimicking Inserts	High-Equivalency Brain, High-Equivalency Adipose, High-Equivalency CT Solid Water
Weight	15.5 kg (34.1 lbs)
Wheeled Case	Included
Stand	Included



Modular Base

The Solid Water® HE base is compatible with two sets of rods for multi-energy CT QA as well as TPS calibration. See page 10 for details.

Advanced Electron Density Phantom

Tissue-Equivalent CT-to-Electron Density Calibration in a Single Workflow

PN 805810



Automated CT-to-Electron Density Analysis

- Patented rod markers* uniquely identify each material in a CT scan
- CT-to-density tables are automatically generated in the **RapidCHECK™** software

Sized for Wide-Beam Applications

- Larger phantom body diameter supports evaluation of cone-beam CT and wide-beam CT scanners
- Removable section for head and small body protocols

Superior Tissue Equivalence & Chamber Compatibility

- Meets medical standards ICRU-44 and ICRP for human tissue densities
- Compatible with any ion chamber

Specifications

Software Analysis	Automatically process CT-to-density tables using RapidCHECK, based on patented rod marker technology
In-plane Dimensions	40.0 cm (15.7 in) x 30.0 cm (11.8 in)
Depth	16.5 cm (6.3 in), up to 26.5 cm (10.2 in) with optional extension plates
Removable Head Section Diameter	20.0 cm (7.87 in)
Material	HE Energy-Matched CT Solid Water®
Interchangeable Inserts	14 solid inserts plus 2 true water containers
Optional Inserts	Aluminum, Stainless Steel, Titanium
Available Upon Request	Extension plates, Ion Chamber conversion rod
Weight	15.5 kg (34.1 lbs)
Wheeled Case & Stand	Included

Standard Inserts

Material	Physical Density (g/cm ³)	Electron Density Relative to Water
455 Lung LN-300	0.29	0.28
485 Lung LN-450	0.45	0.44
1553 HE Gen Adipose	0.96	0.94
1454 HE Breast 50:50	0.98	0.97
4 - 1451 HE CT Solid Water® Inserts	1.02	1.00
1481 HE Brain	1.05	1.02
1482 HE Liver	1.08	1.05
1456 HE Inner Bone	1.21	1.16
484 CB2 + 30% CaCO ₃	1.33	1.27
480 CB2 + 50% CaCO ₃	1.56	1.46
1450 HE Cortical Bone	1.93	1.78
2 - True Water Inserts	1.00	1.00

RapidCHECK™ Software

Automated CT-to-Density Calibration & CT Image Quality Analysis

PN 806017

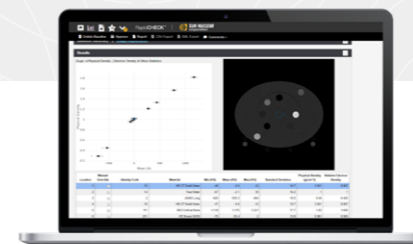

Automate QA Workflows

- Use with **IQphan Phantom** to quickly process CT data into results and reports
- Use with **Advanced Electron Density Phantom** for faster, less-tedious calibration of CT-to-electron density tables
- Use with **CT ACR 464 Phantom** for automation of image quality analysis, trending reports, and an easily searchable permanent record

Browser-Based Software

- Use RapidCHECK software from any browser in your clinical network
- Get results immediately – load data, see analysis, print report, and track changes over time

Specifications

Current Device Compatibility	Advanced Electron Density Phantom, CT ACR 464 Phantom, IQphan
Operating System	Windows 10 Pro with Creators Update (Version 1703) and Fall Creators Update (Version 1709, build 16299), Window 10 Enterprise, or Windows 10 Educational
Regional Settings	US or International
Minimum Computer Specifications	Intel i3 processor; total RAM: 4 GB (8 GB recommended); 10 GB of drive space; Display resolution: 1280 x 1024; Color depth: 32-bit
Browser	Google Chrome® (recommended) or Microsoft Edge®

Mercury 4.0 Phantom

Advanced CT Performance Assessment

PN 805835



Characterize Advanced CT Features

- Address performance and effectiveness of Automatic Exposure Control/Tube Current Modulation
- Evaluate image quality for Iterative Reconstruction
- Meet AAPM TG-233 requirements

CT Protocol Optimization

- 5-tiered sections reflect range of patient sizes, and enable size-dependent image quality evaluation
- Software analysis, featuring ImQuest software licensed from Duke University

Specifications

Material	Polyethylene
Diameter	16.0, 21.0, 26.0, 31.0, and 36.0 cm
Length	52.0 cm
Contrast Materials	HE CT Solid Water®, Bone Mimicking Material, Polystyrene, 10 mg/mL Iodine, and Air
Resolution Wedge	HE CT Solid Water®
Software Analysis	Works with ImQuest software, available from Duke
Included	Wheeled Case and Stand

*U.S. Patent No. 10,939,891

Large Field MR Image Distortion Phantom

Assessing Whole-Body MRI
Geometric Distortion

CIRS Model 604-GS

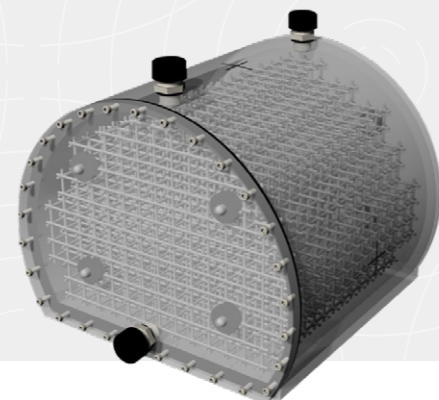

Features

- With a tissue-like medium MRI signal, assess image distortion due to:
 - B_0 field inhomogeneities
 - Gradient nonlinearity
 - Chemical shifts
 - Susceptibility artifacts
- Compatible with Distortion Check software
- Submillimeter control point detection
- Optimized 3D grid spacing fills entire volume
- 2152 control points
- Easy integration and laser alignment
- Ground truth files for grid available

Specifications

Dimensions	300 mm (L), 276 mm (H) , 330 mm (DIA)
Weight (Dry)	17 lb. (7.7 kg)
Weight (Filled)	62 lb. (28.1 kg)
Material	PMMA
Grid Spacing	20.3mm (I-S), 20.5mm (AP) and 21.5mm (L-R). Grid intersections enhanced by 6mm diameter sphere.
Software	Distortion Check software

Model 604-GS Includes

1	Large Field MR Image Distortion Phantom
1	Filling Funnel
10	Extra plastic screws
1	Harness
1	Plastic tray
2	User Guides
1	Foam-Lined Carry Case
Unlimited	Unlimited scans using MRI Distortion Check Software for initial 2 year period

MR Distortion & Image Fusion Head Phantom

Assess MR Image Distortion
in SRS Planning

CIRS Model 603-GS



Characterize Geometric Accuracy for MR use in Treatment Planning

- Assess MR image distortion in SRS planning
- Realistic anthropomorphic scenario for CT and MR imaging
- Presents simulated bony anatomy as rigid landmarks for image fusion
- Special pads compatible with all fixation frames
- CT/MR markers facilitate positioning and image registration

Optimizing SRS QA

- Verify image fusion and deformable image registration algorithms used in various treatment planning systems
- Tissue equivalent, anthropomorphic phantom

Distortion Check Software

- Detects physical control points (859) throughout the 3D image volume
- Cloud-based solution designed to quickly and automatically quantify distortion in MRI images

Specifications

Dimensions	32 cm x 24 cm x 18 cm
Weight	12 lbs (5.5 kg)
Materials	Skull: Plastic-based bone substitute; Interstitial/ Soft tissues: Water-base polymer; Grid: Reinforced nylon
Software	Distortion Check software

Model 603-GS Includes

1	MR Distortion & Image Fusion Head Phantom
1	ABS Cradle
Unlimited	Unlimited scans using MRI Distortion Check Software for initial 2 year period
1	Custom Carry Case

CT Perfusion Phantom

Optimize Imaging & Perfusion Protocols

PN 805607

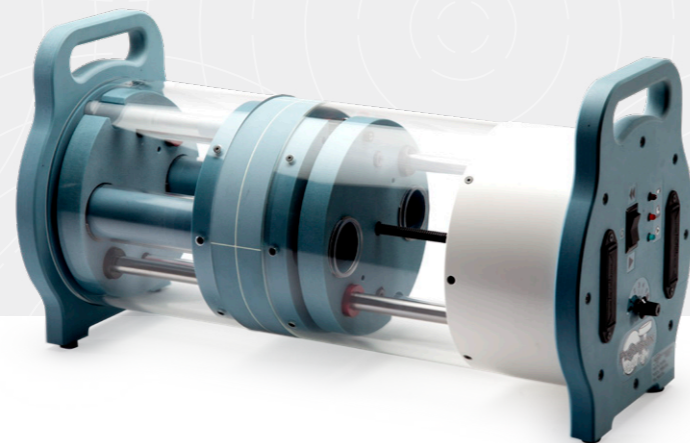

Consistent, Optimized CT Perfusion Programs

- Ensure CT scanner and perfusion software are providing consistent results
- Benchmark perfusion rates and time-attenuation curves for each system
- Meet ACR CT Perfusion and FDA recommendations

Image Gently

- Use the dose port to optimize imaging and perfusion protocols
- Gain insights to image at the lowest possible dose

Specifications

Covers and housings	PVC, Acrylic
Dosimetry Port	Standard CT Pencil Chambers up to 12.7 mm (0.5in) diameter
Central Scan Disk	High Equivalency (HE) Brain Mimicking Material
Artery Rod	16 discrete sections of blood and contrast simulating materials to mimic arterial flow rates following a contrast bolus injection
Vein Rod	16 discrete sections of blood and contrast simulating materials to mimic venous flow rates following a contrast bolus injection
Tissue Rods (Qty 2)	HE Brain Mimicking Material of 16 discrete sections of brain tissue to mimic tissue uptake rates following a contrast bolus injection
Velocity settings (mm/second)	1.31, 1.50, 1.75, 2.10, 2.63 +/- 2%
Rod Travel Distance	10.5 cm (4.1 in)
Dimensions (L/ W/H)	55.5 x 25.4 x 30.5 cm (22 x 10 x 12 in)
Power	8 AA batteries (included)
Weight	13.6 kg (29.9 lbs)

CTDI Phantoms

Computed Tomography Dose Index Phantom

PN 805561 (Two-Piece), PN 805549 (Three-Piece)



Compliance Maintenance

- Measure absorbed dose and monitor scanner output for Dose Index QA
- Address specifications outlined by the FDA (FDA 21CFR 1020.33) and IEC (IEC 60601-2-44, IEC 61223-2-6 and IEC 61223-3-5IEC 60601-2-44)
- Meet AAPM TG-66 requirements

Configurable

- 2-piece configuration supports adult body and adult head/pediatric body sizes
- 3-piece configuration offers an additional pediatric head size
- Nested modules adapt the phantom to the size required by user protocol

Specifications

Material	Polymethyl-Methacrylate (PMMA/Acrylic)
Density	1.19 g/cm ³
Alignment Markings	Etched lines centered at the transverse, coronal and sagittal planes
Module	Dimensions (OD x Length)
Adult Body	32 cm x 14.5 cm
Adult Head/Pediatric Body	16 cm x 14.5 cm
Pediatric Head (Model 468-BHP only)	10 cm x 14.5 cm
Weight	19.9 kg (30.5 lbs)
Chamber Ports Diameter	1.31 cm

Electron Density Phantom

Basic Electron Density Phantom

CIRS Model 062M

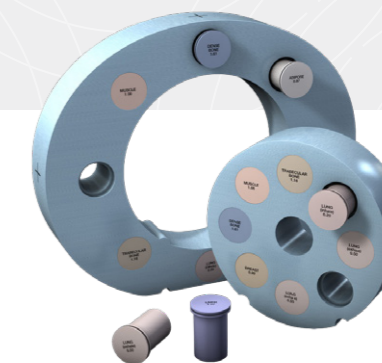

Highlights

- Evaluate CT scan data
- Correct for inhomogeneities
- Document relationship between CT number and tissue electron density
- Simulate indicated tissue within the diagnostic energy range
- Quickly assess distance registration

Specifications

Dimensions	Electron Density Head Insert: Ø 180 mm x 50 mm (Ø x D); Electron Density Body without Head Insert: 330 mm x 270 mm x 50 mm (W x H x D)
Weight	Electron Density Head Insert: ≈ 0.950 kg (2 lbs.); Electron Density Body without Head Insert: ≈ 2.1 kg (4.7 lbs.)
Materials	Water and Tissue Equivalent Epoxy Resins

Visit cirsinc.com for complete specifications, including included and optional parts.

Doppler 403™ Flow & Mini-Doppler 1430™ Flow Phantoms

Reliable, Reproducible System
Velocity Testing



PN 805660 (0.5 dB/cm/MHz),
PN 805661 (0.7)

PN 805204 (0.5 dB/cm/MHz),
PN 805206 (0.7)

Comprehensive QA & Testing

- Determine maximum signal penetration, channel isolation, and flow rate readout accuracy
- Doppler flow and B-Mode QA test systems
- Meet ACR, ECR, and AIUM QA requirements
- **Doppler 403™ Flow Phantom** ideal for abdominal flow measurements
- **Mini-Doppler 1430™ Flow Phantom** ideal for cardiology and musculoskeletal applications

Unparalleled Tissue Mimicking

- Blood-mimicking fluid ultrasonically similar to human tissue
- Patented High Equivalency Gel* (HE Gel™) offers tissue mimicking for evaluating image uniformity, detecting dead transducer elements, and assessing maximum penetration depth

Doppler 403™ Flow Phantom Specifications

HE Gel™ Multi-Frequency Tissue-Mimicking Material	Included
Patented Composite Film Scanning Surface	Included
Vessels (2)	5 mm inner diameter; 1 horizontal at 2 cm depth, 1 diagonal at 40° from 2 to 16 cm deep
Flow Rates	Customizable, constant and pulsatile
Blood Mimicking Fluid	Speed of Sound 1550 +/- 10 m/s
Targets	Strings, cysts, grey scale, resolution groups
Dimensions (Case)	28 H x 30.5 W x 22 cm (11 x 12 x 8.65 in.)
Weight	8.34 kg (18 lbs. 4 oz.)

Mini-Doppler 1430™ Flow Phantom Specifications

HE Gel™ Multi-Frequency Tissue-Mimicking Material	Included
Patented Composite Film Scanning Surface	Included
Vessels (2)	4 mm inner diameter; 1 horizontal at 2 cm depth, 1 diagonal at 35° from 2 to 9 cm deep
Flow Rates	Customizable, constant and pulsatile
Blood Mimicking Fluid	Speed of Sound 1550 +/- 10 m/s
Targets	Strings, cysts, grey scale, resolution groups
Dimensions (Case)	20 H x 23 W x 15.2 cm (7.87 x 9.06 x 5.94 in.)
Weight	4.6 kg (9 lbs. 15 oz.)

Doppler Flow Pump

Flexible Testing Platform
for Doppler Ultrasound

CIRS Model 769



Features

- Simulates blood flow when testing Doppler ultrasound devices.
- Used in conjunction with ATS Urethane or Zerdine phantoms
- Max Flow Rate: 750 mL/min; Min Flow Rate can be as low as 0.04 mL/min (Actual value will vary depending on phantom use)
- Pulsatile or Constant Velocity configurations available
- Doppler fluid simulates acoustic and physical characteristics of blood
- All components stored in compact case for easy transport

Compatible Phantoms

- Peripheral Vascular Doppler Flow Phantom (CIRS Model ATS 524 & 525)
- Doppler Flow Directional Discrimination Phantom (CIRS Model ATS 527)
- Cardiac Doppler Flow Phantom (CIRS Models ATS 523 & 523A)

Specifications

Motor Type	Step motor
Motor Steps per Revolution	200
Microstepping	1/8 to 1/1 depending on motor speed
DC Connector	2.1mm, center positive
Voltage at DC Connector	24V DC at full load
Amperage	900mA at full load
Power Supply Type	Unregulated linear external wall adapter, country and power source specific
Power Supply Output Rating	24V DC @ 1A
Dimensions	9" x 4" x 8" High (23 cm x 10cm x 20 cm)
Weight	4.51 lbs. (2.05 kg)

See cirsinc.com for complete specifications.

Doppler Ultrasound Flow Phantom

Sensitivity & Velocity Doppler Ultrasound QA

CIRS Model 069A

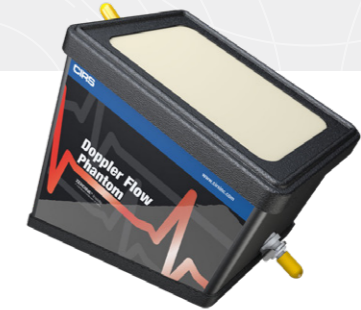

Features

- Tissue-Equivalent Phantom
- Used in conjunction with CIRS Doppler Flow Pump (Model 769)
- Varying tube depths for peripheral and abdominal vessel simulation
- Suitable for doppler sensitivity and velocity accuracy quality assurance testing
- Hard shell case

Specifications

Dimensions	20 cm x 12.5 cm x 27.5 cm
Tubing	Inside Dimensions: 3/16" Outside Dimensions: ¼"
Scan Surface	Saran laminate membrane; 12.5 cm x 17.5 cm
Background Material	Zerdine® SoS: 1540 m/s ± 10 m/s Attenuation: 0.7 dB/cm-MHz

*U.S. Patent No. 6,352,860

Sono403™ Phantom

Multi-Purpose
Ultrasound Phantom

PN 802259 (0.5 dB/cm/MHz), PN 802260 (0.7)



Multi-Purpose B-Mode Ultrasound QA

- Ensure accurate ultrasound system imaging
- Generally compatible with AIUM, ACR, AAPM, IEC 62736, IPEM 102, and EFSUMB TQA QA Guidelines
- Verify system settings and depth of penetration for small to very large patients
- Simulates typical depth through abdomen to the liver
- Precisely placed targets support grey scale and axial resolution system measurements

Unparalleled Tissue Mimicking

- Patented High Equivalency Gel* (HE Gel™) provides multi-frequency, high quality, reproducible images
- Test across the entire frequency range (2 - 18 MHz)

Specifications

Attenuation Coefficient ¹	0.5 or 0.7 dB/cm/MHz
Variation of Attenuation with Frequency ^{2,3}	f ^{1.08} at 0.5 dB/cm/MHz f ^{1.1} at 0.7 dB/cm/MHz
HE Gel Freezing Point	< 0°C
HE Gel Melting Point	>100°C
Frequency Range	2 - 18 MHz
Speed of Sound	1540 m/s
Scanning Surface	Composite Film
Pin Target Material	Nylon monofilament
Cystic Targets Diameters & Placement	2, 4, 6, and 10 mm; 3, 7, 8, and 14 cm deep
Grey Scale Target Diameters & Placement	10 mm; 6 cm deep
Pin Targets Diameter & Placement	0.1 mm; 2 cm at 2 to 16 cm deep vertical spacing, and 3 cm at 2 and 12 cm deep horizontal spacing
Resolution Target Groups Depths	3, 8, and 14 cm deep
Case Material	Extruded ABS Plastic
Weight	~2.8 kg (6 lbs. 5 oz)
Dimensions	23.2 x 8.25 x 18.5 cm (9.25 x 3.25 x 7.25 in.)

Multi-Purpose Ultrasound Phantoms

Complete B-Mode
Multi-Purpose Phantoms

CIRS Models 040GSE, ATS 539 & ATS 570



Model 040GSE Features

- Elastography
- Dual Attenuation Zones (0.7 dB/cm/MHz and 0.95 dB/cm/MHz)
- Supports nearly all transducer shapes
- Zerdine® Hydrogel Material: Speed of sound = 1540 m/s for highest image quality
- Detachable water well

Model ATS 539 Features

- Durable urethane rubber construction
- Supports most transducer shapes
- Permanent water well prevents testing of endo (linear) and some intraoperative probes
- ATS Urethane Rubber Material: Speed of sound = 1450 m/s
- Standard attenuation = 0.5 dB/cm/MHz at 3.5 MHz with nonlinear frequency dependence

Model ATS 570 Features

- Durable urethane rubber construction
- Curved scan surface, endocavity well provide enhanced testing of curved probes and endo(linear)probe
- Supports nearly all transducer shapes
- ATS Urethane Rubber Material: Speed of sound = 1450 m/s
- Standard attenuation = 0.5 dB/cm/MHz at 3.5 MHz with nonlinear frequency dependence
- Detachable water well

Model 040GSE Specifications

Dimensions	17.8 cm x 12.7 cm x 20.3 cm (7" x 5" x 8")
Phantom Weight	11 lbs. (4.1 kg)
Housing Materials	ABS Plastic
Membrane	Saran-based laminate
Tissue-Mimicking Material	Zerdine® solid elastic hydrogel

Model ATS 539 Specifications

Dimensions	23.4 x 20.5 x 9.5 cm (9" x 8" x 4")
Phantom Weight	7 lbs. (3.1 kg)
Housing Materials	PVC
Wall Thickness	1.0 cm
Scan Surfaces	4
Scan Surface Dimensions	17.5 x 7.5 cm 14.0 x 7.5 cm
Tissue-Mimicking Material	Urethane Rubber

Model ATS 570 Specifications

Dimensions	27 x 21.5 x 9.6 cm (11" x 8" x 4")
Phantom Weight	10 lbs. (4.55 kg)
Housing Materials	PVC
Scan Surfaces	2
Scan Wells	1 cm
Tissue-Mimicking Material	Urethane Rubber

*U.S. Patent No. 6,352,860

General Purpose Ultrasound Phantom

Small Parts Phantom

CIRS Model 054GS



Features

- High-value QA solution for ACR test coverage
- Supports nearly all transducer shapes
- Zerdine® Hydrogel Material: Speed of sound = 1540 m/s for highest image quality
- May desiccate (standard attenuation = 0.7 dB/cm/MHz)
- Detachable water well
- Artifacts may be present when testing curved arrays with water well; eliminated when using coupling gel

Specifications

Dimensions	Wax and acrylic equivalent to 4.2 cm thick compressed breast tissue. 50% adipose & 50% glandular. Fibers, specks and masses follow ACR specifications.
Phantom Weight	0.40, 0.54, 0.74, 0.93
Housing Materials	0.20, 0.24, 0.32, 0.54
Membrane	0.25, 0.50, 0.75, 1.00
Tissue-Mimicking Material	6.7 x 6.8 x 6.1 cm

SonoTE™ Phantom & CIRS Model 551

Ultrasound Image

Uniformity Phantoms

Sun Nuclear PN 805331 & CIRS Model 551



Features

- Uniform speckle background for testing image uniformity
- Supports nearly all transducer shapes
- Elastic material conforms to the transducer shape
- Curved surfaces provide enhanced ease of use (SonoTE only)
- Sono TE Material & Attenuation
 - Silicone rubber Material: Speed of sound = 1000 m/s
 - Attenuation > 1 dB/cm/Mhz
- CIRS Model 551 Material & Attenuation
 - Z-skin™ Elastomer Elastic Rubber: Speed of sound = 1470 m/s
 - Attenuation = 0.4 dB/cm/Mhz

SonoTE Specifications

Material	Silicone base
Dimensions (L/W/H)	11.5 x 5.7 x 7.5 cm (4.63 x 2.25 x 3 in)
Weight	580 +/- 5 g (1 lb. 4 oz.)

Model 551 Specifications

Dimensions	Ø 11.2 cm x 7.5 cm
Phantom Weight	2.2 lbs. (1 kg)
Materials	Z-Skin™ elastomer

3D Ultrasound Calibration Phantom

& 3D Wire Test Object Ultrasound Phantoms
for 2D & 3D Evaluation

CIRS Models 055 / 055A



Features

- For advanced volume measurements with 3D probes:
 - Model 055: Wire Targets
 - Model 055A: Egg and Sphere
- Supports nearly all transducer shapes
- Zerdine® Hydrogel Material: Speed of sound = 1540 m/s for highest image quality
- May desiccate (standard attenuation = 0.7 dB/cm/MHz)
- Permanent water well
- Artifacts may be present when testing curved arrays with water well

Model 055 Specifications

Dimensions	15 x 15 x 15 cm
Material	ABS Housing
Scanning Membrane	Saran-based laminate
Scan Window Dimensions	Top: 2 cm x 12 cm Side: 11 cm x 11 cm

Model 055A Specifications

Dimensions	13 x 18 x 11 cm
Material	ABS Housing
Scanning Membrane	Saran-based laminate
Scan Window Dimensions	14 cm x 9 cm

Beam Profile & Slice Thickness Phantom

CIRS Model ATS 538NH



Features

- Slice thickness and beam profile
- Supports nearly all transducer shapes
- ATS Urethane Rubber Material: Speed of sound = 1450 m/s
- Does not desiccate
- Standard attenuation = 0.5 dB/cm/MHz at 3.5 MHz with nonlinear frequency dependence
- Requires coupling gel; no water well
- Depth of penetration may be greater than phantom depth with some low-frequency probes

Specifications

Dimensions	25 x 22 x 7 cm (10" x 9" x 3")
Weight	11 lbs. (5.1 kg)
Housing Materials	PVC
Scan Surfaces	3
Tissue-Mimicking Material	Urethane Rubber

Sono408™ Phantom

Spherical Lesion Phantom

PN 802271 (0.5 dB/cm/MHz), PN 805157 (0.7)



Spherical Lesion B-Mode Ultrasound QA

- Ensure accurate ultrasound system imaging
- Generally compatible with AIUM, ACR, AAPM, IEC 62736, IPEM 102, and EFSUMB TQA QA Guidelines
- Ensure system presets are based image quality, not default settings, for optimal performance
- Ideal for spherical lesions that have negligible echogenicity and produce no distal enhancement or shadowing
- Supports testing high-frequency transducers used in echocardiography

Unparalleled Tissue Mimicking

- Patented High Equivalency Gel* (HE Gel™) provides multi-frequency, high quality, reproducible images
- Test across the entire frequency range (2 - 18 MHz)

Specifications

Attenuation Coefficient ¹	0.5 or 0.7 dB/cm/MHz
Variation of Attenuation with Frequency ^{2,3}	f ^{1.08} at 0.5 dB/cm/MHz f ^{1.1} at 0.7 dB/cm/MHz
HE Gel Freezing Point	< 0°C
HE Gel Melting Point	>100°C
Frequency Range	2 - 18 MHz
Speed of Sound	1540 m/s
Scanning Surface	Composite Film
Cystic Targets Diameters & Placement	2 and 4 mm; 2 mm at 0.5 to 10.5 cm deep and 4 mm at 0.5 to 16 cm deep
Case Material	Extruded ABS Plastic
Weight	2.8 kg (6 lbs. 5 oz)
Dimensions	23.2 x 8.25 x 18.5 cm (9.25 x 3.25 x 7.25 in)

*U.S. Patent No. 6,352,860

Sono405™ Phantom

Troubleshooting Ultrasound Phantom

PN 802267 (0.5 dB/cm/MHz), PN 802268 (0.7)



Troubleshooting B-Mode Ultrasound QA

- Ensure accurate ultrasound system imaging
- Generally compatible with AIUM, ACR, AAPM, IEC 62736, IPEM 102, and EFSUMB TQA QA Guidelines
- Supports Biomedics who need to troubleshoot ultrasound systems
- Two horizontal cross fibers in the middle of the phantom can be used for aligning the transducer and as reference markers to ensure consistent setup over time.
- Triangular grey scale targets support resolution testing of high-performance ultrasound scanners

Unparalleled Tissue Mimicking

- Patented High Equivalency Gel* (HE Gel™) provides multi-frequency, high quality, reproducible images
- Test across the entire frequency range (2 - 18 MHz)

Specifications

Attenuation Coefficient ¹	0.5 or 0.7 dB/cm/MHz
Variation of Attenuation with Frequency ^{2,3}	f ^{1.08} at 0.5 dB/cm/MHz f ^{1.1} at 0.7 dB/cm/MHz
HE Gel Freezing Point	< 0°C
HE Gel Melting Point	>100°C
Frequency Range	2 - 18 MHz
Speed of Sound	1540 m/s
Scanning Surface	Composite Film
Pin Target Material	Nylon monofilament
Cystic Targets Diameters & Placement	2, 4 and 6 mm; 3, 8 and 14 cm deep
Grey Scale Target Diameters & Placement	9.5 x 9.5 x 13.4 mm; 4 cm deep
Pin Targets Diameter & Placements	0.1 mm; 2 cm at 2 to 16 cm deep vertical spacing, and 3 cm at 2 and 12 cm deep horizontal spacing
Resolution Target Groups Depth	3, 8, and 14 cm
Case Material	Extruded ABS Plastic
Weight	~2.8 kg (6 lbs. 5 oz)
Dimensions	23.2 x 8.25 x 18.5 cm (9.25 x 3.25 x 7.25 in)

*U.S. Patent No. 6,352,860

Brachytherapy QA Phantom

CIRS Model 045B



Features

- Supports AAPM Task Group 128: Quality Assurance Tests for Prostate Brachytherapy Ultrasound Systems
- Transrectal Ultrasound
- Zerdine® Hydrogel Material: Speed of sound = 1540 m/s for highest image quality
- May desiccate (standard attenuation = 0.7 dB/cm/MHz)
- Comes with water tank for performing needle alignment test

Model 045B Specifications

Dimensions	14 x 11 x 7.5 cm
Phantom Weight	4 lbs. (1.5 kg)
Housing Material	PVC Plastic
Tank Material	ABS
Membrane	Saran-based laminate
Tissue-Mimicking Material	Zerdine® solid elastic hydrogel

3D Calibration Phantom

CIRS Model ATS 560H



Features

- Combines 3D volume target with Basic QA imaging features
- No side-fire endocavity (permanent water well)
- ATS Urethane Rubber Material: Speed of sound = 1450 m/s
- Does not desiccate
- Standard attenuation = 0.5 dB/cm/MHz at 3.5 MHz with nonlinear frequency dependence
- Permanent water well
- Artifacts may be present when testing curved arrays with water well
- Depth of penetration may be greater than phantom depth with some low-frequency probes

Specifications

Dimensions	23.4 x 20.5 x 9.5cm (9" x 8" x 4")
Phantom Weight	7 lbs. (3.1 kg)
Housing Materials	PVC
Scan Surfaces	4
Scan Surfaces Dimensions	17 x 8 cm 19 x 8 cm
Tissue-Mimicking Material	Urethane Rubber

Invenia ABUS Phantom

CIRS Model ATS UC551-M



Features

- Curved surface allows complete B-mode QA of GE Invenia automated breast ultrasound
- ABUS (GE Invenia) transducer shape
- ATS Urethane Rubber Material: Speed of sound = 1450 m/s
- Does not desiccate
- Standard attenuation = 0.5 dB/cm/MHz at 3.5 MHz with nonlinear frequency dependence

Specifications

Dimensions	28.5 x 12 x 10.6 cm (11" x 5" x 4")
Phantom Weight	8 lbs. (3.6 kg)
Housing Materials	PVC
Scan Surfaces	1
Scan Surfaces Dimensions	26.7 cm x 10 cm Curved, radius of 44.50 cm (17.5")
Tissue-Mimicking Material	Urethane Rubber

General & Small Parts Phantom

CIRS Model 050



Features

- Basic B-mode and 3D testing
 - No greyscale targets
 - Includes 3D Volume targets
- Comprehensive transducer shapes:
 - Curved Abdominal
 - Linear Small Parts
 - Phased-Array
 - Endocavity (end-fire)
 - Endocavity (side-fire)
- Zerdine® Hydrogel Material: Speed of sound = 1540 m/s for highest image quality
- May desiccate (standard attenuation = 0.7 dB/cm/MHz)
- Random spherical voids provide enhanced testing for contrast resolution

Specifications

Dimensions	20 cm x 15 cm x 10 cm (8.5 in x 6 in x 4 in)
Phantom Weight	6.7 lbs. (3 kg)
Housing Material	ABS Plastic
Membrane	Saran laminate ¹
Scanning Well	16.5 cm x 10 cm x 1 cm deep
Tissue-Mimicking Material	Zerdine® solid elastic hydrogel

¹ Saran laminate has been validated for use with clinical small parts probes up to 15 MHz. Users wishing to test higher frequency preclinical imaging systems should contact Sun Nuclear for alternate membranes.

Sono404™ Phantom

Small Parts
Ultrasound Phantom

PN 802261 (0.5 dB/cm/MHz), PN 802262 (0.7)



Small Parts Phantom

CIRS Model ATS 551



Small Parts B-Mode Ultrasound QA

- Ensure accurate ultrasound system imaging
- Generally compatible with AIUM, ACR, AAPM, IEC 62736, IPEM 102, and EFSUMB TQA QA Guidelines
- Supports Cardiology, Breast Care, Musculoskeletal and Vascular applications
- Closely spaced pin targets make it ideal for testing high frequency transducers
- Enables training and testing the most difficult cases, including small parts and intra-cavity ultrasound systems

Unparalleled Tissue Mimicking

- Patented High Equivalency Gel* (HE Gel™) provides multi-frequency, high quality, reproducible images
- Test across the entire frequency range (2 - 18 MHz)

Specifications

Attenuation Coefficient ¹	0.5 or 0.7 dB/cm/MHz
Variation of Attenuation with Frequency ^{2,3}	f ^{1.08} at 0.5 dB/cm/MHz f ^{1.1} at 0.7 dB/cm/MHz
HE Gel Freezing Point	< 0°C
HE Gel Melting Point	>100°C
Frequency Range	2 - 18 MHz
Speed of Sound	1540 m/s
Scanning Surface	Composite Film
Pin Target Material	Nylon monofilament
Cystic Targets Diameters & Placement	1, 2, 4 and 7 mm; 1, 3, 3.5 and 6 cm deep
Grey Scale Target Diameters & Placement	7 mm; 3 cm deep
Pin Targets Diameter & Placement	0.1 mm; 5 mm at 1–9 cm deep vertical spacing, and 10 mm at 1 and 5 cm deep horizontal spacing
Resolution Target Groups Depths	1, 3.5 and 6 cm deep
Case Material	Extruded ABS Plastic
Weight	1.75 kg (3 lbs. 13 oz)
Dimensions	17 x 8.25 x 15.875 cm (6.75 x 3.25 x 6.25 in.)

Features

- Complete B-Mode QA
- Nearly all transducer shapes
- ATS Urethane Rubber Material: Speed of sound = 1450 m/s
- Does not desiccate
- Standard attenuation = 0.5 dB/cm/MHz at 3.5 MHz with nonlinear frequency dependence
- Permanent water well
- Artifacts may be present when testing curved arrays with water well

Specifications

Dimensions	8 x 11 x 11 cm (3" x 4" x 4")
Phantom Weight	7 lbs. (3.1 kg)
Housing Materials	PVC
Scan Surfaces	1
Scan Surfaces Dimensions	25 cm x 8 cm
Tissue-Mimicking Material	Urethane Rubber

Browse all Ultrasound QA Solutions

Visit cirsinc.com/ultrasound to search our full Ultrasound QA selection by:

- QA test support
- Frequency mode
- Material Type

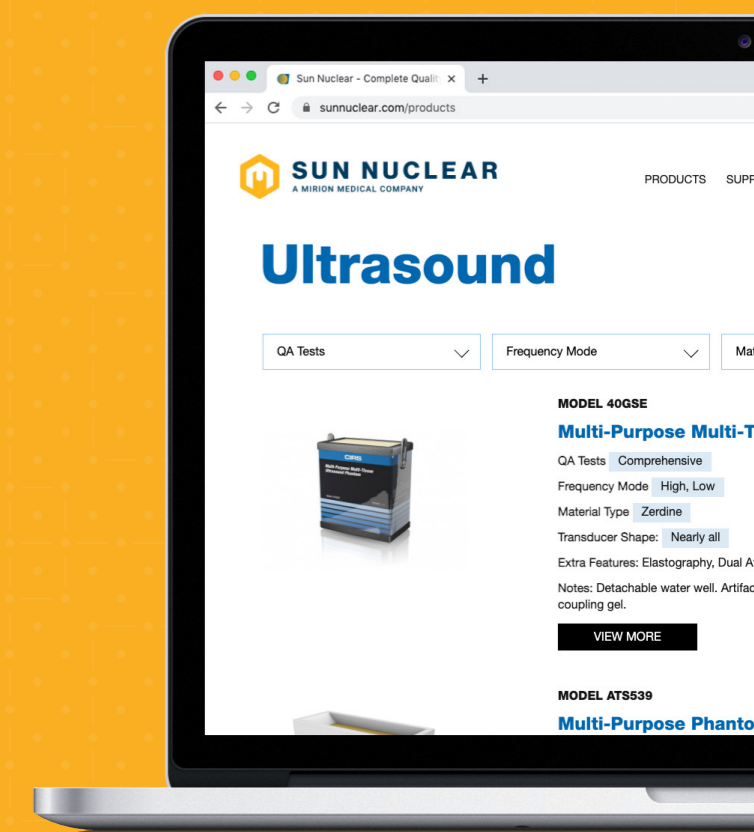

Mammo FFDM™ Phantom

Full Field Digital Mammography

PN 806022

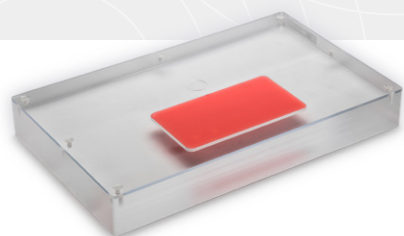

Ensure Optimal FFDM Performance

- Evaluate artifacts over the entire detector with a single image
- Meet ACR, MSQA and EUREF requirements
- Test objects designed and located per ACR specifications, and reduced backscatter and equalized attenuation
- Meets ACR 2018 Digital Mammography Quality Control Manual requirements

Specifications

Materials	Wax and acrylic equivalent to 4.2 cm thick compressed breast tissue
Nylon Fibers	6
Specks	6 Groups, Glass Spheres
Masses	6
Dimensions (L x W x H)	31.0 ± 0.1 x 19 ± 0.1 x 4.1 ± 0.03 cm
Dimensions: Wax Insert (L x W x H)	12.98 (+0, -0.04) x 6.98 (+0, -0.04) x 0.7 ± 0.02 cm
CNR Cavity Depth	0.1 ± 0.005 cm
CNR Diameter	2.0 ± 0.05 cm
Compensator	9 mil Polyvinylidene Chloride
Case	Soft case included; Optional custom hard-sided case, with 1-year warranty, available (PN 805772)

See sunnuclear.com for wax insert test object specifications.

Mammo 3D™ Performance Kit

Digital Mammography System QC

PN 805857



Acceptance Testing for 3D Tomosynthesis Systems

- Includes PMMA plates, spacers, aluminum plates and foils, steel plates and customized test tools
- Meet IEC Protocol 601223-3-6, EUREF/EFOMP 1.03 (Tomosynthesis), & German DIN 6868-14 requirements
- Custom case included

PMMA Plates, Spacers, & Phantoms

Standard Test Plate	1 - 320 x 260 x 45 mm
10 mm PMMA Plate	7 - 320 x 260 x 10 mm
15 mm PMMA Plate	1 - 320 x 260 x 5 mm
2 mm PMMA Plates	7 - 40 x 20 x 2 mm
10 mm PMMA Spacers	2 - 180 x 15 x 10 mm
30 mm PMMA Spacers	2 - 180 x 30 x 30 mm
Geometric Distortion & Z-Resolution Phantom	1 - 320 x 260 x 5 mm

Aluminum Plates & Foils

2 mm Aluminum Plate	1 - 100 x 100 x 2 mm
0.2 mm Aluminum Foil Sheet	1 - 10 x 10 x 0.2 mm
0.1 mm Aluminum Foil Sheets	8 - 100 x 100 x 0.1 mm

Steel Plates

3 mm Stainless Steel Plate	1 - 320 x 260 x 3 mm
MTF Edge Tool	1 - 120 x 60 x 0.6 mm

Wire, Spacers, X-ray Rulers

25 micron Tungsten Wire (cm)	100
Polystyrene Foam Spacers	5 - 240 x 180 x 20 mm
1mm scale X-ray Rulers	4 - +2.5 to -5 cm

Mammo 156™ Phantom

Digital Mammography System QC

PN 800004

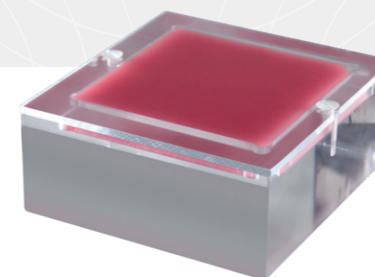

Measure & Monitor Digital Mammography Systems

- Meet ACR and MQSA requirements.
- Simulates radiographic characteristics of 4.2 cm compressed breast tissue
- Quickly detect objects from 0.16 to 2.0 mm
- Includes 4 mm acrylic disc included to establish and monitor density differences

Specifications

Materials	Wax and acrylic equivalent to 4.2 cm thick compressed breast tissue. 50% adipose & 50% glandular. Fibers, specks and masses follow ACR specifications.
Nylon Fibers (monofilament) DIA (mm)	0.40, 0.54, 0.74, 0.93
Micro-calcifications (Aluminum Oxide) DIA (mm)	0.20, 0.24, 0.32, 0.54
Masses DIA (mm)	0.25, 0.50, 0.75, 1.00
Dimensions (L x W x H)	6.7 x 6.8 x 6.1 cm
Case (PN 805296)	Optional soft-sided case with foam insert, with 1-year warranty

Mammo 156D™ Phantom

Biopsy and Localization

PN 805298

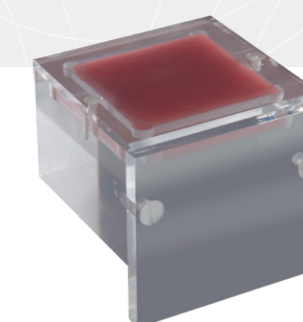

Stereotactic Breast Biopsy QC

- Meet ACR and MQSA requirements.
- Quickly detect objects from 0.20 to 1.00 mm – visible on any system, but, by design, difficult to see on the best stereotactic mammography systems
- Can hang on the biopsy system detector during rotation

Specifications

Materials	Wax and acrylic equivalent to 4.2 cm thick compressed breast tissue. 50% adipose & 50% glandular
Nylon Fibers (Fibrils)	6
Micro-calcifications	5 Groups
Masses	5
Dimensions (L x W x H)	10.2 x 10.8 x 4.5 cm
Case (PN 805296)	Optional soft-sided case with foam insert, with 1-year warranty

Contrast Enhanced Spectral Mammography Phantom

Simple, Comprehensive
Routine CESM QA

CIRS Model 022



Features

- Daily and routine QC
- Tests performance and stability of CESM
- Contains clinically relevant iodine concentrations
- Represents both dense and fatty breasts
- Background provides clinically relevant challenge for target detection

Specifications

Overall Dimensions	180 mm x 127 mm x 100 mm
Individual Slab Dimensions	3 Slabs: 180 mm x 110 mm x 10 mm, 1 Slab: 180 mm x 110 mm x 25 mm
Phantom Weight	1.4 kg (3.09 lb)
Materials	BR50/50, 100% Gland and Adipose

Mammo CESM™ Phantom

QC for Contrast Enhanced
Spectral Mammography

PN 805929

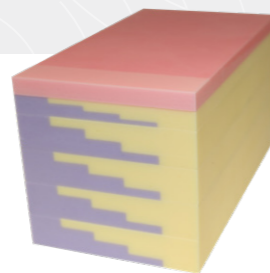

Independently Verify Beam Qualities

- Stack of modules supports a variety of tests across a range of iodine concentrations and breast glandularity
- Blocks can be arranged to represent compressed breast for small to large patients

Specifications

Overall Weight	1.8 kg (4 lbs)		
Carrying Case Weight	1.4 kg (3 lbs)		
Overall Stack Dimensions (L x W x H)	181 x 100 x 100 mm (7-1/8 x 4 x 4 in)		
Hard Case	Included		
Warranty	5 years		
	Breast-Iodine Step Block Characteristics	GL/AD Step Block, 10 mm	GL/AD Step Block, 20 mm
Materials	1454 HE Breast 50/50, 1454 HE Breast 50/50 doped with 10 mg/ml Iodine (pink)	1453 HE Br. Adipose (yellow), 1466 HE Glandular (purple)	1453 HE Br. Adipose (yellow), 1466 HE Glandular (purple)
Quantity	1	1	4
Length x Width	181 x 100 mm	181 x 100 mm	181 x 100 mm
Thickness	10 mm	10 mm	10 mm
Step Increments	1 mm	2.5 mm	5 mm

Digital Breast Tomosynthesis QC Phantom

Thorough Tomosynthesis
System Performance Testing

CIRS Model 021

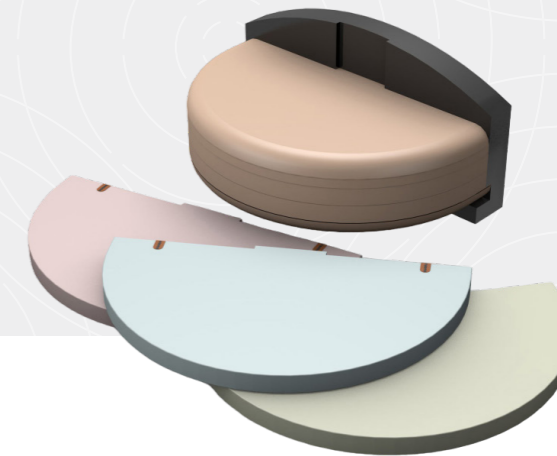

Comprehensive Digital Testing

- Acceptance testing, daily and routine QC
- Tests image quality and stability of DBT systems
- Consistent, repeatable targets in homogeneous background
- Optional complex background provides clinically relevant challenge for target detection
- Slab configurations provide range of thicknesses with or without targets
- Developed to meet developing requirements of EUREF and AAPM TG-245

Specifications

Overall Dimensions	127 mm x 80 mm x 100 mm
Individual Slab Dimensions	6 Slabs: 110 mm x 180 mm x 10 mm; 1 Slab: 115 mm x 180 mm x 10 mm (support slab); 1 Slab: 110 mm x 180 mm x 5 mm, semicircular shape
Phantom Weight	1.62 kg (3.55 lbs)
Materials	BR50/50, BRSW5050

Stereotactic Needle Biopsy Phantom

Enabling Critical Testing & Training

CIRS Model 013



Highlights

- For use in localization accuracy test per ACR's stereotactic breast biopsy accreditation program
- Use upon system installation or repair, to ensure accurate needle placement
- Anthropomorphic shape allows accurate simulation of breast compression
- Re-usable - will not dry out, or leak when punctured; Masses can be biopsied multiple times
- 11 dense masses in three sizes; Two microcalcification clusters
- Compatible with standalone and add-on stereotactic biopsy systems

Specifications

Dimensions	10 cm x 16.6 cm x 5 cm (6.5" x 2.5" x 4")
Phantom Weight	1.0 lb. (0.4 kg)
Phantom Volume	530 cc
Material	Polyurethane

Ultrasound Needle Breast Biopsy Phantom with Amorphous Lesions

Designed for Training & Experimentation

CIRS Model 52A

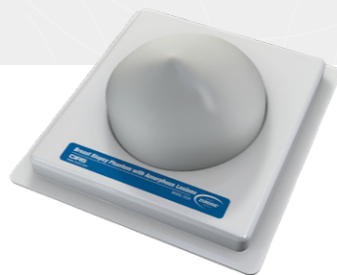

Highlights

- Non-spherical shape of embedded targets enable practice with 2D, 3D and 4D image acquisition
- Accurately mimics ultrasonic characteristics of tissues found in average human breast
- Size and shape of simulates average patient in the supine position
- Six cystic masses and six dense masses, randomly positioned
- Contains cysts which can be aspirated, solids which can be biopsied

Specifications

Tray Dimensions	22.5 cm x 20 cm x 7.5 cm (9" x 8")
Breast Size	600 cc (14 cm x 12 cm at base, 7.5 cm high)
Background Material	Zerdine®, white
Cystic Masses	Qty: 6; Color: Green; Size: 8-15 mm; Position: Random
Dense Masses	Qty: 6; Color: Black; Size: 6-12 mm; Position: Random

Multi-Modality Breast Biopsy and Sonographic Trainer

A Versatile Tool for Shaping Best Practices

CIRS Model 73

Highlights

- Designed to train users in aspects of breast imaging and image-guided interventional procedures - X-ray, Ultrasound, MRI
- Includes cystic and dense lesions embedded within breast background
 - Half of dense lesions spherical with embedded 100-300 micron microcalcification, half with spiculated shape
 - Calcifications serve as useful markers for image registration between modalities
- Features patent-pending Z-Skin™ membrane to simulate skin, providing protection from desiccation even after multiple sessions

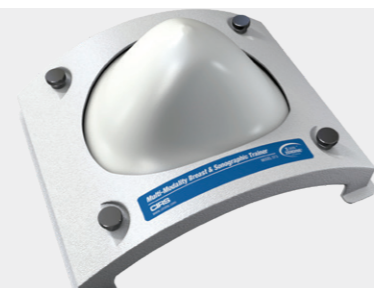

Specifications

Tray Dimensions	26 cm x 23 cm x 7.5 cm (10" x 9" x 3")
Breast Size	500 cc (14 cm x 11 cm at base, 8 cm high)
Total Weight	1 lb. (0.4 kg)
Membrane Material	Z-Skin™ elastomer
Background Material	Zerdine®, white
Cystic Masses	Qty: 5-10
Dense Masses	Material: Zerdine®-based, anechoic under ultrasound

Mammo Digital Compression Device

Compression Force Measurement for Accuracy and Reproducibility

PN 805939



Specifications

Accuracy	±0.01 lb [0 - 2 lb], ±0.02 lb [2 - 75 lb] ±0.005 kg [0 - 1 kg], ±0.01 kg [1 - 34 kg]
Display Units	g, lb:oz, kg, lb, oz
Scale Dimensions	8.9 x 8.2 x 2.9 in (225 x 208 x 73 mm)
Foam Compression Block (included)	Polyethylene Foam 7.25 x 4.75 x 1 in (184 x 108 x 25.4 mm)
Scale Weight	2 lbs. (0.95 kg)
Power	Alkaline Batteries Size C (4x), not included
RoHS Compliant, CE Mark	Yes
Case (PN 805972)	Optional Soft Case not included

Phototimer Consistency Tools

Test Automatic Exposure Control (AEC) Performance

PN 801811, PN 801810



Specifications

Construction	7 pieces of Acrylic (Phototimer Consistency Tools) 7 Pieces of Breast Tissue Equivalent Materials (Phototimer Consistency Tools-BR)
Phototimer Consistency Tools Sizes	3 each of 14 x 14 x 1.90 cm ± 2.0 mm; 2 each of 14 x 14 x .95 cm ± 1.5 mm; 2 each of 14 x 14 x 0.48 cm ± 1.0 mm
Phototimer Consistency Tools-BR Sizes	3 each of 14 x 14 x 2 cm ± 0.2 mm; 2 each of 14 x 14 x 1 cm ± 0.2 mm; 2 each of 14 x 14 x 0.5 cm ± 0.2 mm
Case	Phototimer Consistency Tools: 2.3 kg (4.3 lbs) Phototimer Consistency Tools -BR: 1.95 kg (4.3 lbs)



Mammo Film Screen Contact Test Tool

Early Artifact Detection

PN 800052

Screen Size	24 x 30 cm (9.4 x 11.8 in)
Mesh	#40 Mesh - Copper
Size	25.8 x 31.5 cm (10.2 x 12.4 in)
Weight	0.4 kg (0.9 lbs)

Key Mammography QA Resources

Go to sunnuclear.com for:

- Demos: Request One-on-One Presentations
- Webinar: Customer Experience with Mammo FFDM Phantom
- Datasheets: Mammography Phantoms

Aluminum Step Wedge

PN 800013



Construction	High Purity Aluminum Alloy and Copper, 9 steps 0.3 mm high x 1.4 cm deep
Size	14.2 x 4 cm (5.6 x 1.9 in)
Weight	10 g (0.4 oz)

Beam Alignment Test Tool

PN 800423



Construction	Acrylic Cylinder
Height	16 cm (6.3 in)
Diameter	7 cm (2.8 in)
Weight	260 g (9.2 oz.)
Construction	Acrylic Cylinder
Warranty	5 Years

Grid Alignment Test Tool

PN 800420



Construction	Three Lead Blockers with Precise Hole Locations
Dimensions	9 x 23.5 cm (3.5 x 9 in) - one large, two small
Weight	0.7 kg (1.5 lbs)
Warranty	1 Year

Collimator Alignment Test Tool

PN 805818

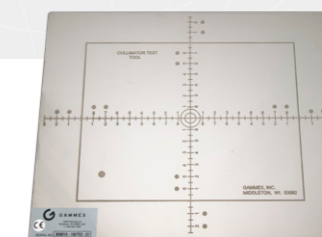

Construction	Etched Stainless Steel
Dimensions	20.0 x 25.0 cm (8.0 x 10.0 in)
Weight	200 g (6.2 oz.)
Warranty	5 Years

DR, CR, & Fluoroscopy Solutions

Perform quality control testing of your Digital Radiography (DR), Computed Radiography (CR) and Fluoroscopy X-ray systems with ease.

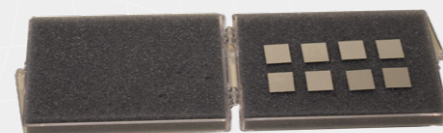

Signal Difference to Noise Ratio (SDNR) Set

PN 805760

Construction	Aluminum Alloy 99.0%
Size	10 cm x 10 cm
Thickness	0.2 mm

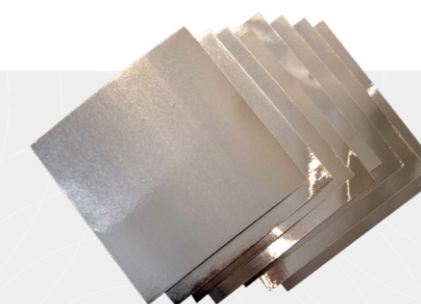

Half Value Layer (HVL) Attenuator Sets

PN 800012 (115A), PN 805755 (115B), PN 800051 (115H)

Construction	115A - 99.00% High Purity 1100 Aluminum Alloy; 115B - 99.00% High Purity 1100 Aluminum Alloy; 115H - 99.99% Ultra High Purity Aluminum
Quantity	115A - 9; 115B - 8; 115H - 6
Thickness/Quantity	115A - 0.1 mm (3), 0.2 mm (1), 0.5 mm (2), 1.0 mm (2), 2.0 mm (1) 115B - 0.1 mm (8) 115H - 0.1 mm (6)
Length	10 cm (4 in)
Width	10 cm (4 in)

Fluoroscopic Dose Rate & Low Contrast Resolution Test Tool Kit

PN 800421



Construction	2 Aluminum Blocks, 1 Lead Blocker, 1 Aluminum Resolution Plate
Dimensions	18 x 18 x 4.5 cm (7 x 7 x 1.8 in)
Weight	4 kg (8.8 lbs)
Warranty	5 Years

DR QC Phantom

CIRS Model 139702



Dimensions	17" x 17" x ~1/2"
Weight	8 lb
Materials	PMMA, Copper, Aluminum
Model 139702 Includes	
1	DR QC Phantom

High Contrast Resolution Test Tool

(141H) – High-Res, 60-150 Mesh; (141) – Standard, 16-60 Mesh

PN 800417, PN 800416

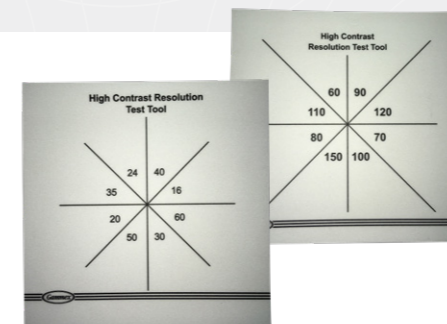

Geometric Progression	2 1/3
Construction	White Plastic (outside)
Wire Mesh Patterns (inside)	8 - 60 to 150 mesh (141H High-Res) 8 - 16 to 60 mesh (141 Standard)
Dimensions	18 x 18 x 1 cm (7 x 7 x 0.4 in)
Weight	113 g (4 oz)
Warranty	1 Year

Half Value Layer Attenuator Set, Copper Alloy 110

PN 805159



Construction	Copper Alloy 110
Dimensions	5 pieces, each 17 cm x 17 cm x 0.5 mm

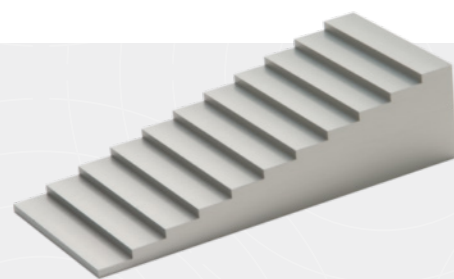

Radiographic Aluminum Stepwedge, 11 Steps (117)

PN 800414

Construction	6061 Aluminum Alloy
Steps	Eleven (11) steps, 3.2 mm high and 12.7 mm deep
Dimensions	14 x 6 cm (5.5 x 2.4 in)
Weight	450 g



Half Value Layer Attenuator Set, Pure Copper (116)

PN 800413

Construction	Pure Copper
Dimensions	10 x 10 cm (4 x 4 in)
Weight	0.55 kg (1.1 lbs)
Sheet Count	9 individual copper sheets
Thickness	1 - 2.0 mm 2 - 1.0 mm 1 - 0.5 mm 1 - 0.25 mm 4 - 0.1 mm

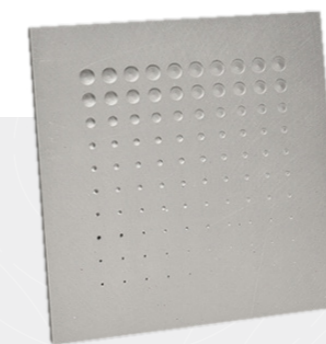

Contrast Detail Tool

PN 801745

Material	6061 Aluminum
Hole Depths	0.13 to 2.29 mm
Hole Diameters	0.58 to 7.93 mm
Dimensions (L/W/H)	18.0 x 18.0 x 1.3 cm (7.1 in x 7.1 in x 0.5 in)
Weight	1.0 kg (2.2 lbs.)



Radiography Fluoroscopy QA Phantom

CIRS Model 903

Dimensions	25.4 cm x 25.4 cm x 20.3 cm (10" x 10" x 8")
Phantom Weight	16.8 kg (37 lb)
Materials	PMMA-equivalent epoxy
Includes	1 - Test Object Plate; 1 - 4.1 cm Block with Lead Markers; 1 - 7.6 cm Block with Aluminum Plate & Detachable Support Legs; 1 - 7.6 cm Block

Ultra Star Test Pattern (1-360°) & Ultra Star Test Pattern (4-15°)

PN 800021, PN 800431

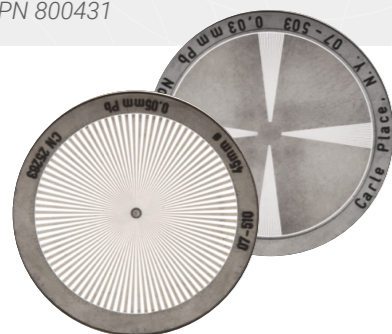

Lead Foil Thickness	0.05 mm
Diameter	55 mm
Angle of Single Line within a Sector	0.5°
Number and Size of Patterned Sector	1-360°; 4-15°
Focal Spot Size Measured	0.1-0.3 mm
Warranty	5 Years

Anthropomorphic Neo-Natal Chest Phantom

PN 805248



Size	Approx. 100 x 100 x 54 mm
Weight	Approx. 500 grams
Composition	Tissue Equivalent Materials: Air, Muscle, Normal Lung, Hyaline Membrane Lung, Bone
Warranty	5 Years

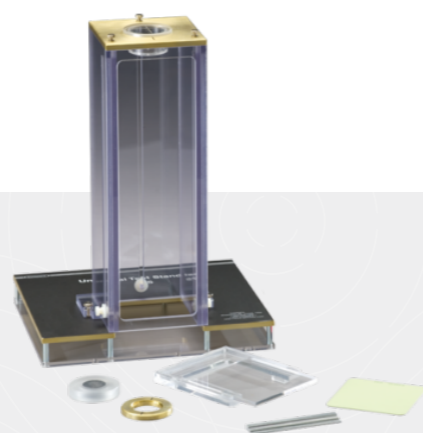

Universal Test Stand (175)

PN 802203

Dimensions	26.7 x 22.2 cm at base (10.5 x 8.75 in) 11.1 x 11.1 cm at top (4.4 x 4.4 in)
Height	Adjustable from 36.2 cm to 66.0 cm (14.3 to 20 in)
Weight	4.2 kg (9.3 lbs)

Resolution Test Pattern, 5.0-20 LP/mm, 16 groups

PN 800647



Resolution	5.0 - 20 lp/mm
Dimensions	8 x 28 mm (5/16 x 1-7/16 in)
Thickness	0.03 mm

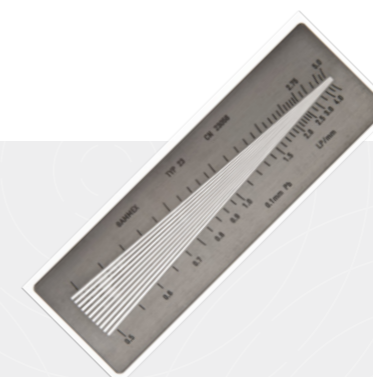

Resolution Test Pattern, 1 sector

PN 800437

Dimensions	157 x 50 mm (6.2 x 1.9 in)
Weight	9 g (0.3 oz)

Resolution Test Pattern, 0.6-5.0 bar, 20 groups

PN 800438

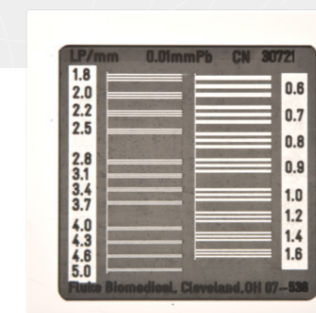

Resolution	0.6 to 5.0 lp/mm
Dimensions	50 x 50 mm (1.9 x 1.9 in.)
Thickness	PN 800438 0.01 mm PN 800439 0.10 mm

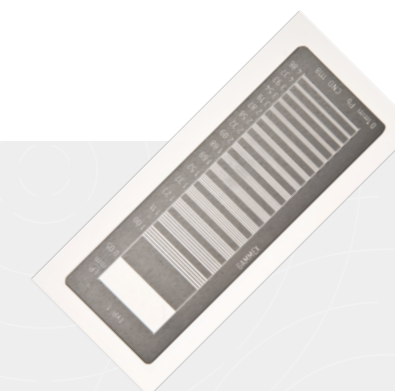

Resolution Test Pattern, 0.5-4.86 LP/mm bar, 16 groups

PN 800436

Dimensions	110 x 40 mm (4.3 x 1.6 in)
Weight	9 g (0.3 oz.)

Focal Spot Test Tool

PN 800428



Construction	Six-inch acrylic cylinder with a 12-group bar pattern target mounted on top
Dimensions	0.84 to 5.66 lp/mm
Warranty	5 Years



**Sun Nuclear
Headquarters (US)**

Phone
+1 (321) 259-6862

Address
3275 Suntree Blvd,
Melbourne, FL 32940

**Sun Nuclear
Wisconsin (US)**

Phone
+1 (800) 426-6391

Address
7600 Discovery Drive,
Middleton, WI 53562

**Sun Nuclear
CIRS, Virginia (US)**

Phone
+1 (757) 855-2765

Address
900 Asbury Ave
Norfolk, VA 23513

**Sun Nuclear
GmbH**

Phone
+49 6102-50495-00

Address
Gutenbergring 67 A 22848
Norderstedt, Germany

**SunServices™
Center - EMEA**

Phone
+31 20 399 90 41

Address
Verlengde Poolseweg 36
4818 CL Breda, The Netherlands



SUN NUCLEAR
A MIRION MEDICAL COMPANY

©2023 Mirion Technologies, Inc. or its affiliates. All rights reserved. Sun Nuclear, the Sun Nuclear logo, and other trade names of Sun Nuclear products listed herein are registered trademarks or trademarks of Mirion Technologies, Inc. or its affiliates in the United States and other countries. Third party trademarks mentioned are the property of their respective owners. All Rights Reserved. All data used is best available at time of publication. Data is subject to change without notice.

